

# KATALOG 2019



F E R R A M E N T A



**+420 548 212 958**

**+420 605 271 559**

Linky zákaznické a technické podpory.



**incoll@incoll.cz**

E-mail určený k objednávkám a obchodní komunikaci



### **Speciální poptávky**

Sháníte zboží, které není uvedeno v katalogu? Zašlete nám prosím Vaši poptávku a my se pokusíme Vám sortiment zajistit prostřednictvím sítě výrobců, se kterými spolupracujeme



### **Technické listy, montážní návody, certifikáty**

Součástí tohoto katalogu zpravidla nejsou montážní návody a technické listy. Požádejte si o ně prostřednictvím našeho zákaznického servisu, případně u svých obchodních zástupců



### **On-line objednávky [www.incoll.cz](http://www.incoll.cz)**

Vaši objednávku můžete vytvořit i prostřednictvím on-line objednávkového systému. Po přihlášení se Vám zobrazí Vaše nákupní ceny a další důležité informace. Přihlašovací údaje žádejte u svých obchodních zástupců, případně na zákaznickém servise

# 45

let historie INCOLL, zaručuje dostatek zkušeností v oblasti nákupu a prodeje nábytkového kování a doplňků. Jsme přímými dovozci zboží z Asie a Itálie. Plošným materiálům se věnujeme pouze okrajově, ale představujeme originální produkty, případně produkty ve vysoké kvalitě made in Italy.

# 95

% zboží z tohoto katalogu jsou standardní skladové položky společnosti INCOLL FERRAMENTA, s.r.o. V praxi to znamená, že zboží obsažené v tomto katalogu je zpravidla ihned dostupné.

# 24

hodin je čas, mezi přijetím Vaší objednávky a odesláním zboží k Vám. Vaše objednávka bude po přijetí ihned zpracována a zpravidla odeslána tentýž nebo následující pracovní den.

# 0.1

% je poměr reklamací vůči celkovému obrátu v posledních 3 letech. To vše díky spolupráci s pouze prověřenými dodavateli a striktní kontrole kvality. Takové zboží nabízíme pod obchodní značkou THE LEVEL, Teknoline a Easy. Tyto produkty jsou ve většině případů testovány a následně certifikovány CATAS, SGS nebo TÜV. Mnohé z nich mají i svůj vlastní patent.

# 4

týdny jsou obvyklý termín dodání zboží s poznámkou „skladová dostupnost na dotaz“. Tento termín se zpravidla pohybuje od jednoho do čtyř týdnů, ale v mnoha případech může být toto zboží i skladem, proto je nutné telefonicky kontaktovat zákaznický servis a dostupnost si ověřit, případně se dohodnout na termínu dodání.

# 30

a více je počet našich obchodních partnerů z oblasti Itálie. Mezi nejvýznamnější z nich patří společnosti Formenti e Giovenzana (FGV), Danco, Italfeltri, Unionplast, Elletipi, Inoxa Industrie, Compagnucci, Crolla rubinetti, Manart, Paludet Mario. Významnou skupinu našich dodavatelů z Itálie pak tvoří malí výrobci, jejichž produkty jsou ve vysoké kvalitě, ale často dokáží cenou konkurovat produktům asijské výroby.

<b>1</b>	<b>ZÁVĚSY</b>	<b>6-17</b>
	S tlumením	7-8
	Klipové	9-10
	Slide-on	11-13
	Mini a na sklo	14-15
	Pružinové dveřní	15
	Tlumiče dorazu	16
	Pushe, magnety	16-17

<b>2</b>	<b>VÝSUVY</b>	<b>18-25</b>
	Kuličkové plnovýsuvy s tlumením	19
	Kuličkové plnovýsuvy	20
	Mikrovýsuvy	20
	Rolničkové	20-21
	Skryté s tlumením	21
	Zásuvkové boxy	22-23
	Výsuvy s kovovou bočnicí	24-25
	Stolové	25

<b>3</b>	<b>VÝKLOPNÉ SYSTÉMY</b>	<b>26-29</b>
	Výklopný mechanismus	27
	Plynové vzpěry s tlumením	27
	Plynové vzpěry	28
	Teleskop s regulací	29
	Výklopné botníky	29
	Klopný závěs	29

<b>4</b>	<b>STOLOVÉ NOHY</b>	<b>30-35</b>
	Kulaté	31
	Hranaté	32
	Centrální podnože	32-35
	Kancelářské podnože	35

<b>5</b>	<b>KOLEČKA A NOŽKY</b>	<b>36-45</b>
	Pohledové nožky	37-38
	Soklové nožky	39-41
	Regulační a závrtné nožky	42
	Kluzáky	43
	Kolečka	43-45

<b>6</b>	<b>NOSIČE POLIC</b>	<b>46-53</b>
	Podpěrky polic	47
	Držáky polic, konzole	48-49
	Skryté konzole	49-50
	Rektifikační kování	50-52
	Zarážkové lišty	53

<b>7</b>	<b>ÚCHYTKY, VĚŠÁKY</b>	<b>54-61</b>
	Úchytky	55-59
	Věšáky	59-61

<b>8</b>	<b>KUCHYŇSKÝ PROGRAM</b>	<b>62-78</b>
	Lahvovníky	63-64
	Slepé rohy	65-66
	Potravinové skříně	67
	Příborníky	68-70
	Odpadkové koše	71-73
	Kuchyňské sokly	74-75
	Těsnící lišty	76
	Dna lednice, Syphon flex	77
	Vodovodní baterie	77-78
	Dřezy	79
	Protiskluzové podložky	79

<b>9</b>	<b>VYBAVENÍ SKŘÍŇÍ</b>	<b>80-85</b>
	Šatní tyče	81
	Výklopné věšáky	82
	Věšáky na kalhoty a kravaty	82-83
	Výsuvné věšáky	83
	Koš na prádlo	83
	Posuvný systém dveří	84

<b>10</b>	<b>KANCELÁŘSKÉ DOPLŇKY</b>	<b>86-91</b>
	Větrací mřížky	87
	Kabelové průchodky	88
	Točny	89
	Výsuvy klávesnice, PC vozíky	89
	Kabelové svody	90
	Zásuvkové věže a boxy	91

<b>11</b>	<b>SPOJOVACÍ KOVÁNÍ</b>	<b>92-105</b>
	Spoj.šrouby a hmoždinky	93-95
	Vruty	95-96
	Úhelníky	96
	Postelové kování	97
	Postelové mechanismy	98
	Zámky	99
	Samolepící krytky	100
	Practical way	101-103
	Kolíky, lamelky	104

<b>12</b>	<b>PLOŠNÉ MATERIÁLY</b>	<b>106-109</b>
	MDF desky lesk a super mat	107
	ABS hrany	108
	MDF desky beton	109

# ZÁVĚSY

## ZÁVĚS INTEGRA (s integrovaným tlumením)

OBJ.ČÍSLO	POPIS	SPECIFIKACE
-----------	-------	-------------

51.BSH5.05.00.05000	naložený	klip
51.BSH5.05.08.05000	polonaložený	klip
51.BSH5.05.15.05000	vložený	klip

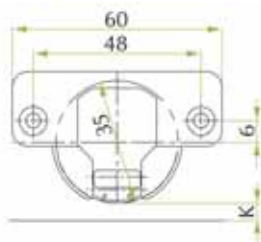

## PODLOŽKY INTEGRA

### > KLIPOVÉ VRUT, EURO



OBJ.ČÍSLO	VÝŠKA	POPIS
52.5B01.M5.00.10000	H0	vrut
52.5B01.M5.02.10000	H2	vrut
52.5B01.M5.04.10000	H4	vrut
52.5B16.M5.00.B1000	H0	euro

### > 3D



OBJ.ČÍSLO	VÝŠKA	POPIS
52.RB44.L5.00.05000	H0	vrut

## DOPLŇKY INTEGRA

### > KRYTKA MISKY

OBJ.ČÍSLO	POPIS
51.5CB0.05.00B00	krytka misky



### > KRYTKA RAMÍNKA

OBJ.ČÍSLO	POPIS
51.5Y00.05.000000N	krytka ramínka INTEGRA



## ZÁVĚS S TLUMENÍM KLIPOVÝ

OBJ.ČÍSLO	POPIS	SPECIFIKACE
D51.1005.20	naložený, H0	set s podložkou
D51.1085.20	polonaložený, H0	set s podložkou
D51.1155.20	vložený, H0	set s podložkou
D51.1005.20A	naložený, H0	set s podložkou a krytkami



**LEVEL**  
THE LEVEL

## ZÁVĚS S TLUMENÍM S 3D EXCENTR. PODLOŽKOU



OBJ.ČÍSLO	POPIS	SPECIFIKACE
D52.1005.20	naložený, H0	set s 3D podložkou
D52.1085.20	polonaložený, H0	set s 3D podložkou
D52.1155.20	vložený, H0	set s 3D podložkou

**LEVEL**  
THE LEVEL

## TLUMIČE ZÁVĚSŮ FGV



> ALFA

**OBJ.Č.**

59.0620.05.0000000

Vhodná pro všechny závěsy klipové i SLIDE-ON mimo 175°



> DELTA

**OBJ.Č.**

59.550D.M50W00000

Pro závěsy klip a SLIDE-ON 175°





## ZÁVĚSY A PODLOŽKY FGV OPTIMA KLIP



OBJ.ČÍSLO	POPIS	VARIANTA
51.XSH5.05.00.CA000	naložený	klip, 110°
51.XSH5.05.08.CA000	polonaložený	klip, 110°
51.XSH5.05.15.CA000	vložený	klip, 110°



### > PODLOŽKY FGV OPTIMA KLIP

OBJ.ČÍSLO	VÝŠKA	SPECIFIKACE
52.0401.M5.02.S000	H2	klip, vrut
52.0401.M5.04.S000	H4	klip, vrut
52.0416.M5.02.BS000	H2	klip, euro

## ZÁVĚSY A PODLOŽKY DANCO KLIP

OBJ.ČÍSLO	POPIS	SPECIFIKACE
54.1G06.B00.20	naložený	klip, 45 mm
54.1G06.B08.20	polonaložený	klip, 45 mm
54.1G06.B15.20	vložený	klip, 45 mm



OBJ.ČÍSLO	POPIS	SPECIFIKACE
54.1G11.B35.20	naložený	180°, klip



OBJ.ČÍSLO	POPIS	SPECIFIKACE
54.1G09.B00.20	naložený	175°, klip

NA HLINÍKOVÝ  
RÁMEČEK



OBJ.ČÍSLO	POPIS	SPECIFIKACE
54.AG06.B00.20	naložený	alum, klip
54.AG06.B08.20	polonaložený	alum, klip
54.AG06.B15.20	vložený	alum, klip

> **PODLOŽKY DANCO CLIP**

OBJ.ČÍSLO	VÝŠKA	SPECIFIKACE
54.2G02.B01.20	H1	vrut, klip
54.2G01.C01.20	H1	euro, klip



**ZÁVĚSY A PODLOŽKY KLIP**



OBJ.ČÍSLO	POPIS	PODLOŽKA
52.1G06.B00.20E	naložený	H0, vrut
52.1G06.B08.20E	polonaložený	H0, vrut
52.1G06.B15.20E	vložený	H0, vrut



## ZÁVĚSY A PODLOŽKY FGV MS SLIDE-ON



**OBJ.ČÍSLO**

51.MS15.05.00.C  
51.MS15.05.08.C  
51.MS15.05.15.C

**POPIS**

naložený  
polonaložený  
vložený

135°



**OBJ.ČÍSLO**

51.MS83.M5.35.C0000

30°



**OBJ.ČÍSLO**

51.MS85.05.30.CA000

45°



**OBJ.ČÍSLO**

51.MS85.05.45.CA000

90°



**OBJ.ČÍSLO**

51.MS85.M5.90.CA000

175°



**OBJ.ČÍSLO**

51.MW15.M5.00.C0000

## PODLOŽKY FGV MS SLIDE-ON

**OBJ.ČÍSLO**

52.0201.M5.00.1R000  
52.0201.M5.02.1R000  
52.0201.M5.04.1R000  
52.0216.M5.02.DR000

**PODLOŽKA**

H0  
H2  
H4  
H2

**SPECIFIKACE**

vrut, slideon  
vrut, slideon  
vrut, slideon  
euro, slideon



## ZÁVĚSY DANCO SLIDE-ON



OBJ.ČÍSLO	POPIS
54.1B01.B00.20	naložený
54.1B01.B08.20	polonaložený
54.1B01.B15.20	vložený
54.1B01.D00.20	naložený



30°

**OBJ.ČÍSLO**

54.1B14.B30.20



45°

**OBJ.ČÍSLO**

54.1B14.B45B.20 naložený  
54.1B14.B45M.20 polonaložený  
54.1B14.B45A.20 vložený



90°

DLOUHÉ  
RAMÍNKO

**OBJ.ČÍSLO**

54.1B14.B90.20



90°

KRÁTKÉ  
RAMÍNKO

**OBJ.ČÍSLO**

54.1B14.B90P.20



175°

**OBJ.ČÍSLO**

54.1B09.B00.20



180°

**OBJ.ČÍSLO**

54.1B11.B35.20



110°

VHODNÝ  
PRO PUSH

**OBJ.ČÍSLO**

54.1B50.B00.20 naložený obrácený  
54.1B50.B08.20 polonaložený obrácený  
54.1B50.B15.20 vložený obrácený

## PODLOŽKY DANCO SLIDE-ON



OBJ.ČÍSLO	PODLOŽKA	SPECIFIKACE
54.2B05.B01.20	H1	vrut, slideon
54.2B05.B12.20	H12	vrut slideon
54.2B06.C01.20	H1	euro, slideon

## ZÁVĚSY A PODLOŽKY SLIDE-ON



> 110°

OBJ.ČÍSLO	POPIS
52.1B01.B00.20	naložený
52.1B01.B08.20	polonaložený
52.1B01.B15.20	vložený



> PODLOŽKY SLIDE-ON 110°

OBJ.ČÍSLO	PODLOŽKA	SPECIFIKACE
52.2B05.B02.20	H2	vrut, slideon
52.2B05.B04.20	H4	vrut, slideon
52.2B06.C02.20	H2	euro, slideon
52.2B06.C04.20	H4	euro, slideon

LEVEL  
THE LEVEL

## SADY ZÁVĚSŮ SLIDE-ON (ZÁVĚS + PODLOŽKA)

> 110°

OBJ.ČÍSLO	POPIS	PODLOŽKA	SPECIFIKACE
52.1B01.B00.20E	naložený	H0	vrut
52.1B01.B08.20E	polonaložený	H0	vrut
52.1B01.B15.20E	vložený	H2	vrut



45°



> S PODLOŽKOU  
H0 VRUT

OBJ.ČÍSLO  
52.1B14.B45.20E

90°



> S PODLOŽKOU  
H4 VRUT

OBJ.ČÍSLO  
52.1B14.B90.20E

175°



> S PODLOŽKOU  
H0 VRUT

OBJ.ČÍSLO  
52.1B09.B00.20E

180°



> S PODLOŽKOU  
H0 VRUT

OBJ.ČÍSLO  
52.1B11.B35.20E

## ZÁVĚSY FGV MINI SLIDE-ON

OBJ.ČÍSLO	POPIS
51.QS15.05.00.02000	naložený
51.QS15.05.08.02000	polonaložený
51.QS15.05.15.02000	vložený



### > PODLOŽKY FGV MINI SLIDE-ON

OBJ.ČÍSLO	POPIS	SPECIFIKACE
52.0301.M5.02.100	H2	vrut, slideon
52.0301.M5.04.100	H4	vrut, slideon



## ZÁVĚSY DANCO MINI SLIDE-ON

OBJ.ČÍSLO	POPIS
54.1C08.F00.20	naložený
54.1C08.F08.20	polonaložený
54.1C08.F15.20	vložený



### > PODLOŽKY DANCO MINI SLIDE-ON

OBJ.ČÍSLO	VÝŠKA	SPECIFIKACE
54.2C05.B01.20	H1	mini, vrut, slideon
54.2C06.C01.20	H1	mini, euro, slideon



## ZÁVĚSY DANCO NA SKLO



OBJ.ČÍSLO	POPIS	SPECIFIKACE
54.1H08.F00.20	naložený	mini,slideon, sklo
54.1H08.F08.20	polonaložený	mini,slideon, sklo
54.1H08.F15.20	vložený	mini,slideon, sklo

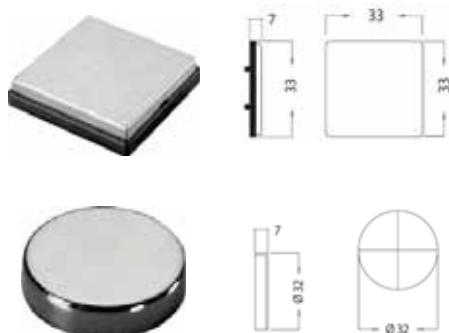

### > KRYTKY K ZÁVĚSŮM NA SKLO

PRODUKT	POVRCHOVÁ ÚPRAVA, TVAR
54.3B00.026.10	Chrom, kulatá
54.3B00.026.50	Černá, kulatá
54.3B00.026.50	nikl satín, kulatá
54.3C00.033.22	broušený nikl, hranatá



### > PODLOŽKY DANCO NA SKLO SLIDE-ON

OBJ.ČÍSLO	VÝŠKA	SPECIFIKACE
54.2C05.B01.20	H1	mini, vrut, slideon
54.2C06.C01.20	H1	mini, euro, slideon

## PRUŽINOVÝ ZÁVĚS KYVNÝCH DVEŘÍ

### > NIKL

OBJ.ČÍSLO	VELIKOST	DĚLKA MM
50.AZ.7529.21	29	75
50.AZ.1030.21	30	100
50.AZ.1233.21	33	125
50.AZ.1536.21	36	150

### > MOSAZ

OBJ.ČÍSLO	VELIKOST	DĚLKA MM
50.AZ.7529.35	29	75
50.AZ.1030.35	30	100
50.AZ.1233.35	33	125
50.AZ.1536.35	36	150



## TLUMIČE DORAZU

### > EASY

OBJ.ČÍSLO	ODSTÍN
04.300.N01.09	šedá
04.300.N01.50	bílá

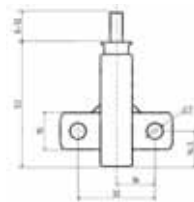

### > THE LEVEL

OBJ.ČÍSLO	ODSTÍN
04.310.N00.09	šedá

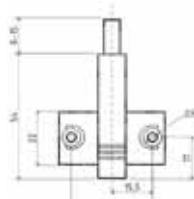

### > BIGAIR - VZDUCHOVÝ

OBJ.ČÍSLO	ODSTÍN
04.303.001.09	šedá

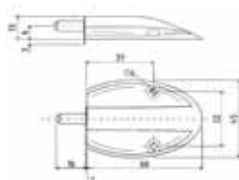

## SYSTEM OTEVÍRÁNÍ DVÍŘEK „PUSH“



### > PUSH 308

OBJ.ČÍSLO	DORAZ	ODSTÍN
04.308.G86.51	čočka	bílá
04.308.G86.55	čočka	šedá
04.308.M86.51	magnet	bílá
04.308.M86.55	magnet	šedá



### > PUSH 311

OBJ.ČÍSLO	DORAZ	ODSTÍN
04.311.G86.55	čočka	šedá

## SKŘÍŇOVÝ MAGNET

### > EASY

OBJ.ČÍSLO	ODSTÍN
04.049.A48.50	bílá
04.049.A48.5H	hnědá
04.049.A48.54	černá







### > SKŘÍŇOVÝ MAGNET SOFT

OBJ.Č.	POPIS	ODSTÍN
04.049.F48.50.A	zavírání soft + magnet	bílá
04.049.F48.54.A	zavírání soft + magnet	černá
04.049.F48.5H.A	zavírání soft + magnet	hnědá
04.049.F48.50.B	protiplech soft + magnet	bílá
04.049.F48.54.B	protiplech soft + magnet	černá
04.049.F48.5H.B	protiplech soft + magnet	hnědá



Zaoblené linie dodávají produktu lehkost a charakter designového prvku, přičemž neztrácí na funkčnosti, kvalitě a nezávadnosti. Odpovídá všem hygienickým normám z hlediska údržby, produkt je možné použít i v provozu, kde je kladen vysoký důraz na hygienu (nemocniční provoz, laboratoře a podobně)

**PATENTED**



Uzavírací zarážka je vyrobena z měkké gumy, která pohlcuje náraz a zaručuje tak tiché a bezpečné uzavírání. Magnet je součástí obou dílů (zarážka i „protiplech“) a je ve stejné síle. Při jejich spojení se síla zdvojnásobuje



KATALOG  
2021

# VÝSUVY



## KULIČKOVÉ PLNOVÝSUVY

### > FGV BBS SLOWMOTION PLNOVÝSUV S TLUMENÍM

OBJ.ČÍSLO	DÉLKA MM	NOSNOST KG
54.5145.C7.30X.00	300	40
54.5145.C7.35X.00	350	40
54.5145.C7.40X.00	400	40
54.5145.C7.45X.00	450	40
54.5145.C7.50X.00	500	40
54.5145.C7.55X.00	550	40
54.5145.C7.60X.00	600	40



### > LEVEL BBS SLOWMOTION PLNOVÝSUV S TLUMENÍM

OBJ.ČÍSLO	DÉLKA MM	NOSNOST KG
08.091.H30.05	300	45
08.091.H35.05	350	45
08.091.H40.05	400	45
08.091.H45.05	450	45
08.091.H50.05	500	45
08.091.H55.05	550	45
08.091.H60.05	600	45
08.091.H65.05	650	45
08.091.H70.05	700	45

### > PLNOVÝSUV „PUSH“

OBJ.ČÍSLO	DÉLKA MM	NOSNOST KG
08.091.P25.05	250	45
08.091.P30.05	300	45
08.091.P35.05	350	45
08.091.P40.05	400	45
08.091.P45.05	450	45
08.091.P50.05	500	45
08.091.P55.05	550	45
08.091.P60.05	600	45



## > KULIČKOVÝ PLNOVÝSUV LEVEL

OBJ.ČÍSLO	DÉLKA MM	NOSNOST KG
08.091.B25.05	250	40
08.091.B30.05	300	40
08.091.B35.05	350	40
08.091.B40.05	400	40
08.091.B45.05	450	40
08.091.B50.05	500	40
08.091.B55.05	550	40
08.091.B60.05	600	40
08.091.B65.05	650	40
08.091.B70.05	700	40
08.091.B80.05	800	40



**LEVEL**  
THE LEVEL

## MIKROVÝSUVY

OBJ.ČÍSLO	DÉLKA MM	NOSNOST KG
08.091.019.05	190	10
08.091.022.05	220	10
08.091.025.05	250	10
08.091.028.05	280	10
08.091.031.05	310	10
08.091.034.05	340	10



**teknoline**

## ROLNÍČKOVÉ VÝSUVY

### > FGV COMFY 082

OBJ.ČÍSLO	DÉLKA MM	NOSNOST KG
54.5082.L1.25.01020	250	25
54.5082.L1.30.01020	300	25
54.5082.L1.35.01020	350	25
54.5082.L1.40.01020	400	25
54.5082.L1.45.01020	450	25
54.5082.L1.50.01020	500	25
54.5082.L1.55.01020	550	25
54.5082.L1.60.01020	600	25



**FGV**  
FORMENTI &  
GIOVENZANA



### > EASY

OBJ.ČÍSLO	DÉLKA MM	NOSNOST KG
05.065.250.62	250	25
05.065.300.62	300	25
05.065.350.62	350	25
05.065.400.62	400	25
05.065.450.62	450	25
05.065.500.62	500	25
05.065.550.62	550	25
05.065.600.62	600	25

## SKRYTÉ VÝSUVY

### > FGV EXCEL S TLUMENÍM A 3D REGULACÍ (LAMINO 18 mm)



OBJ.ČÍSLO	DÉLKA MM	NOSNOST KG	SPECIFIKACE
54.565B.07.30.XE	300	30	3D regul. 100% výsuv
54.565B.07.35.XE	350	30	3D regul. 100% výsuv
54.565B.07.40.XE	400	30	3D regul. 100% výsuv
54.565B.07.45.XE	450	30	3D regul. 100% výsuv
54.565B.07.50.XE	500	30	3D regul. 100% výsuv
54.565B.07.55.XE	550	30	3D regul. 100% výsuv



### > FGV EXCEL S TLUMENÍM (LAMINO 16 mm)

#### 100% VÝSUV

OBJ.ČÍSLO	DÉLKA MM	NOSNOST KG	SPECIFIKACE
54.N650.H7.25.Y0050	250	30	100% výsuv
54.N650.H7.30.Y0050	300	30	100% výsuv
54.N650.H7.35.Y0050	350	30	100% výsuv
54.N650.H7.40.Y0050	400	30	100% výsuv
54.N650.H7.45.Y0050	450	30	100% výsuv
54.N650.H7.50.Y0050	500	30	100% výsuv
54.N650.H7.55.Y0050	550	30	100% výsuv

#### 80% VÝSUV

OBJ.ČÍSLO	DÉLKA MM	NOSNOST KG	SPECIFIKACE
54.N550.H7.45.Y0050	450	25	80% výsuv
54.N550.H7.50.Y0050	500	25	80% výsuv



## FGV TEN ZÁSUVKOVÝ BOX

### > OBJEDNACÍ ČÍSLO KOMPLETNÍHO BOXU H90

DÉLKA	ŠEDÁ	BÍLÁ
270	58.A6.090.270.SP	58.F1.090.270.SP
350	58.A6.090.350.SP	58.F1.090.350.SP
400	58.A6.090.400.SP	58.F1.090.400.SP
450	58.A6.090.450.SP	58.F1.090.450.SP
500	58.A6.090.500.SP	58.F1.090.500.SP
550	58.A6.090.550.SP	58.F1.090.550.SP

1 pár bočnice H90 (L+P), 1 pár plnovýsuv s tlumením(L+P),  
1x sada přichytů čela a zad na vrut, 2x FGV krytka bočnice



### > OBJEDNACÍ ČÍSLO KOMPLETNÍHO BOXU H150

DÉLKA	ŠEDÁ	BÍLÁ
270	58.A6.150.270.SP	58.F1.150.270.SP
350	58.A6.150.350.SP	58.F1.150.350.SP
400	58.A6.150.400.SP	58.F1.150.400.SP
450	58.A6.150.450.SP	58.F1.150.450.SP
500	58.A6.150.500.SP	58.F1.150.500.SP
550	58.A6.150.550.SP	58.F1.150.550.SP

1 pár bočnice H90 (L+P), 1 pár plnovýsuv s tlumením(L+P),  
1x sada držáků čela na vrut (L+P), 1x sada držáků zad na vrut  
(L+P), 1x sada relingů (L+P), 2x FGV krytka bočnice

### > OBJEDNACÍ ČÍSLO KOMPLETNÍHO BOXU H180

DÉLKA	ŠEDÁ	BÍLÁ
270	58.A6.180.270.SP	58.F1.180.270.SP
350	58.A6.180.350.SP	58.F1.180.350.SP
400	58.A6.180.400.SP	58.F1.180.400.SP
450	58.A6.180.450.SP	58.F1.180.450.SP
500	58.A6.180.500.SP	58.F1.180.500.SP
550	58.A6.180.550.SP	58.F1.180.550.SP

1 pár bočnice H90 (L+P), 1 pár plnovýsuv s tlumením(L+P),  
1x sada držáků čela na vrut (L+P), 1x sada držáků zad na vrut  
(L+P), 1x sada relingů (L+P), 2x FGV krytka bočnice

### > SADA PRO VNITŘNÍ ZÁSUVKU TEN

	DÉLKA	POPIS	ROZMĚRY
ŠEDÁ	58.PX4A.A6.10.81B	čelní profil	1081mm/ H90
	58.AX40.S6.00.00B	držáky čel. prof. L+P	H90
BÍLÁ	58.PX4A.F1.10.81B	čelní profil	1081mm/ H90
	58.AX40.F1.00.00B	držáky čel. prof. L+P	H90



### > VRTACÍ ŠABLONA

OBJ. ČÍSLO A0.P200.00.000



**CATAS**  
120.000 CYKLŮ



## PREMIUM BOX

### > VÝSUV PREMIUM BOX PK-100



OBJ. ČÍSLO	ODSTÍN	DÉLKA (L)	VÝŠKA (H)
52.3PB1.300.55	šedá	300 mm	100 mm
52.3PB1.350.55	šedá	350 mm	100 mm
52.3PB1.400.55	šedá	400 mm	100 mm
52.3PB1.450.55	šedá	450 mm	100 mm
52.3PB1.500.55	šedá	500 mm	100 mm
52.3PB1.550.55	šedá	550 mm	100 mm

### > VÝSUV PREMIUM BOX PK-101



OBJ. ČÍSLO	ODSTÍN	DÉLKA (L)	VÝŠKA (H)
52.3PB2.300.55	šedá	300 mm	180 mm
52.3PB2.350.55	šedá	350 mm	180 mm
52.3PB2.400.55	šedá	400 mm	180 mm
52.3PB2.450.55	šedá	450 mm	180 mm
52.3PB2.500.55	šedá	500 mm	180 mm
52.3PB2.550.55	šedá	550 mm	180 mm

### > VÝSUV PREMIUM BOX PK-102



OBJ. ČÍSLO	ODSTÍN	DÉLKA (L)	VÝŠKA (H)
52.3PB3.300.55	šedá	300 mm	220 mm
52.3PB3.350.55	šedá	350 mm	220 mm
52.3PB3.400.55	šedá	400 mm	220 mm
52.3PB3.450.55	šedá	450 mm	220 mm
52.3PB3.500.55	šedá	500 mm	220 mm
52.3PB3.550.55	šedá	550 mm	220 mm

\*Premium boxy lze objednat i v bílém provedení.

### > SADY PRO VNITŘNÍ VÝSUV

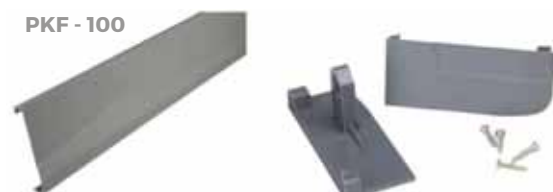

OBJ. ČÍSLO	ODSTÍN	VÝŠKA (H)
52.3VZ1.100.55	šedá	100 mm
52.3VZ2.101.55	šedá	180 mm
52.3VZ3.102.55	šedá	220 mm



Obsah balení:

**PKF - 100:**  
přední lišta 1100mm, 2x příchyt lišty

**PKF - 101:**  
přední lišta 1100mm, 2x příchyt lišty, relingová tyč 1100mm, úchytka

**PKF - 102:**  
přední lišta 1100mm, 2x příchyt lišty, relingová tyč 1100mm, úchytka

## VÝSUVY S KOVOVOU BOČNICÍ

### > FGV UNIBOX

#### H55\*

OBJ.Č.	DÉLKA V MM	ODSTÍN
58.0551.C1.250.000	250	bílá
58.0551.C1.270.000	270	bílá
58.0551.C1.350.000	350	bílá
58.0551.C1.400.000	400	bílá
58.0551.C1.450.000	450	bílá
58.0551.C1.500.000	500	bílá
58.0551.C1.550.000	550	bílá

#### H85\*

OBJ.Č.	DÉLKA V MM	ODSTÍN
58.0651.C1.25G.000	250	bílá
58.0651.C1.27G.000	270	bílá
58.0651.C1.35G.000	350	bílá
58.0651.C1.40G.000	400	bílá
58.0651.C1.45G.000	450	bílá
58.0651.C1.50G.000	500	bílá
58.0651.C1.55G.000	550	bílá

#### H117\*

OBJ.Č.	DÉLKA V MM	ODSTÍN
58.0751.C1.25G.000	250	bílá
58.0751.C1.27G.000	270	bílá
58.0751.C1.35G.000	350	bílá
58.0751.C1.40G.000	400	bílá
58.0751.C1.45G.000	450	bílá
58.0751.C1.50G.000	500	bílá
58.0751.C1.55G.000	550	bílá

#### H150\*

OBJ.Č.	DÉLKA V MM	ODSTÍN
58.0851.C1.25G.000	250	bílá
58.0851.C1.27G.000	270	bílá
58.0851.C1.35G.000	350	bílá
58.0851.C1.40G.000	400	bílá
58.0851.C1.45G.000	450	bílá
58.0851.C1.50G.000	500	bílá
58.0851.C1.55G.000	550	bílá

\*Skladová dostupnost na dotaz.





## VÝSUVY S KOVOVOU BOČNICÍ

### > EASY

#### > H85 (skladem)

OBJ.ČÍSLO	DÉLKA MM	ODSTÍN
52.3B01.270.62	270	bílá
52.3B01.350.62	350	bílá
52.3B01.400.62	400	bílá
52.3B01.450.62	450	bílá
52.3B01.500.62	500	bílá
52.3B01.550.62	550	bílá

#### > H118\*

OBJ.ČÍSLO	DÉLKA MM	ODSTÍN
52.3D01.270.62	270	bílá
52.3D01.350.62	350	bílá
52.3D01.400.62	400	bílá
52.3D01.450.62	450	bílá
52.3D01.500.62	500	bílá
52.3D01.550.62	550	bílá

#### > H150 (skladem)

OBJ.ČÍSLO	DÉLKA MM	ODSTÍN
52.3F01.350.62	350	bílá
52.3F01.400.62	400	bílá
52.3F01.450.62	450	bílá
52.3F01.500.62	500	bílá
52.3F01.550.62	550	bílá



\*Skladová dostupnost na dotaz.



## STOLOVÉ VÝSUVY A PŘÍSLUŠENSTVÍ



### > MODEL 111

OBJ.Č.	DÉLKA
10.111.600.05	600 mm

### > MODEL 112 SYNCHRO

OBJ.Č.	DÉLKA
10.112.600.05	600 mm
10.112.800.05	800 mm



### > ČEPY K ZAJIŠTĚNÍ STOLU

OBR.	OBJ.Č.	Ø
A	10.117.047.05	47 mm
B	10.137.A08.35	8 mm



KATALOG 2.9

# VÝKLOPNÉ SYSTÉMY

## VÝKLOPNÉ SYSTÉMY

### > FGV AEROBUS D40

OBJ.ČÍSLO	POPIS	TYP	VÝŠKA DVÍŘEK (mm)	VÁHA DVÍŘEK (Kg)
59.0VBS.A9.D40.0000	sada AeroBus	D40	180	5.3 - 12.3
			250	3.8 - 8.9
			300	3.2 - 7.4
			400	2.4 - 5.5

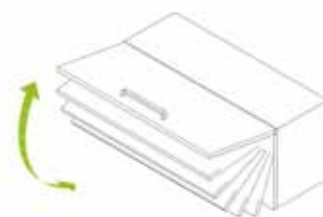

### > FGV AEROLIFT VZPĚRA S TLUMENÍM

OBJ.ČÍSLO	SÍLA N°
59.5K10.06.06X.3000	60
59.5K10.06.08X.3000	80
59.5K10.06.10X.3000	100

### > THE LEVEL VZPĚRA S TLUMENÍM

OBJ.ČÍSLO	SÍLA N°
03.0540.E06.11	60
03.0540.E08.11	80
03.0540.E10.11	100
03.0540.E12.11	120



## FGV AEROLIFT VZPĚRA

### > STANDARTNÍ

OBJ.ČÍSLO	SÍLA N°
59.5K10.06.060.3000	60
59.5K10.06.080.3000	80
59.5K10.06.100.3000	100
59.5K10.06.120.3000	120

### > REVERZNÍ

OBJ.ČÍSLO	SÍLA N°
59.5K20.06.060.3000	60
59.5K20.06.080.3000	80
59.5K20.06.100.3000	100



## THE LEVEL PLYNOVÁ VZPĚRA

### > STANDARTNÍ

OBJ.ČÍSLO	SÍLA N°
03.0539.E05.11	50
03.0539.E06.11	60
03.0539.E08.11	80
03.0539.E10.11	100
03.0539.E12.11	120
03.0539.E15.11	150

### > REVERZNÍ

OBJ.ČÍSLO	SÍLA N°
03.0539.E00.11	60

### > KRÁTKÁ

OBJ.ČÍSLO	SÍLA N°
03.0539.C06.11	60
03.0539.C08.11	80



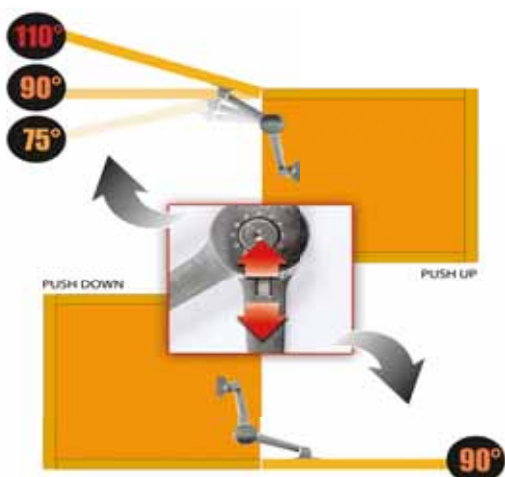

> TELESKOP VÝKLOPNÝ S REGULACÍ

OBJ. ČÍSLO	SPECIFIKACE
03.0537.L00.20	s regulací



> VÝKLOPNÉ BOTNÍKY

OBJ. ČÍSLO	POČET POLÍ	ODSTÍN
21.1723.T00.51	3	bílá
21.1724.T00.51	2	bílá

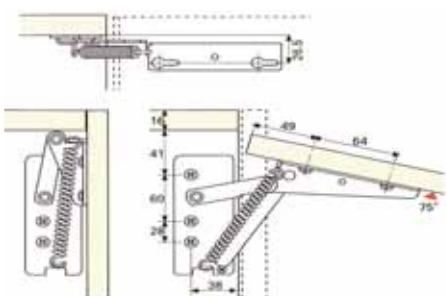
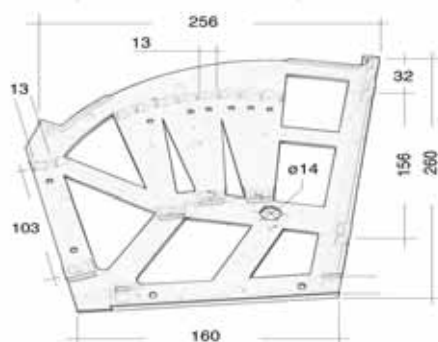
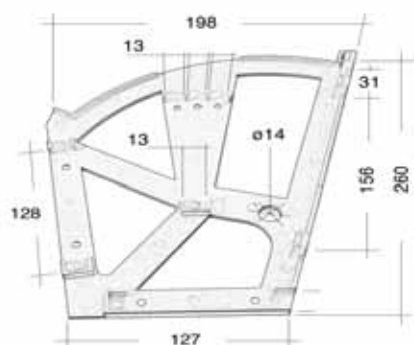

> KLOPNÝ ZÁVĚS

OBJ.Č.	POPIS
38.CR75.A01.20	klopnový závěs



KATALOŽ 2019

# STOLOVÉ NOHY

## STOLOVÉ NOHY KULATÉ

### > H 710 mm

OBJ.ČÍSLO	POPIS	ODSTÍN
24.GP00.071.09	H710, pr. 60	RALL 9006
24.GP00.071.10	H710, pr. 60	chrom
24.GP00.071.11	H710, pr. 60	chrom mat
24.GP00.071.13	H710, pr. 60	nikl satin
24.GP00.071.21	H710, pr. 60	nikl mat
24.GP00.071.52	H710, pr. 60	bílá
24.GP00.071.54	H710, pr. 60	černá

### > H 820 mm

OBJ.ČÍSLO	POPIS	ODSTÍN
24.GP00.082.09	H820, pr. 60	RALL 9006
24.GP00.082.10	H820, pr. 60	chrom
24.GP00.082.11	H820, pr. 60	chrom mat
24.GP00.082.13	H820, pr. 60	nikl satin
24.GP00.082.21	H820, pr. 60	nikl mat
24.GP00.082.52	H820, pr. 60	bílá
24.GP00.082.54	H820, pr. 60	černá

### > H 1100 mm

OBJ.ČÍSLO	POPIS	ODSTÍN
24.GP00.110.09	H1100, pr. 60	RALL 9006
24.GP00.110.10	H1100, pr. 60	chrom
24.GP00.110.11	H1100, pr. 60	chrom mat
24.GP00.110.54	H1100, pr. 60	černá

### > PŘÍRUBA KE STOLOVÝM NOHÁM

OBJ.ČÍSLO	POPIS	MATERIÁL
24.GP00.000.50	možno objednat zvlášť	zamak

LEVEL  
THE LEVEL



## STOLOVÉ NOHY S CENTRÁLNÍM PŘICHYCENÍM

OBJ.ČÍSLO	POPIS	ODSTÍN
24.GP00.071.10A	H710, pr. 60	chrom
24.GP00.071.54A	H710, pr. 60	černá



## STOLOVÉ NOHY HRANATÉ

OBJ.ČÍSLO	POPIS	POVRCH.ÚPRAVA
G31.Q671.22	60x60 H=710mm	nerez



OBJ.Č.	VÝŠKA	POVRCHOVÁ ÚPRAVA*
G31.N671.09	H710	hliník elox
G31.N671.54	H710	černá
G31.N671.51	H710	bílá
G31.N671.01	H710	nerez

\*Skladová dostupnost na dotaz.

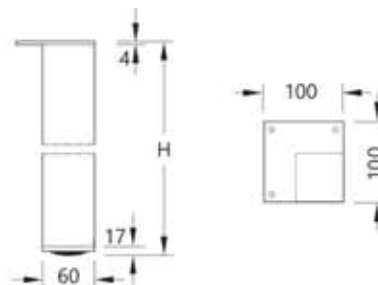

## CENTRÁLNÍ PODNOŽE

### > PETITE N72\*

OBJ.Č.	H/NOHA Ø/PODSTAVA Ø	POVRCH.ÚPR.	MAX.VELIKOST DESKY
24.GG12.N72.10	740/60/390	CHROM	Ø 600

\*Skladová dostupnost na dotaz.







> PETITE N71\*

OBJ.Č.	H/NOHA Ø/PODSTAVA Ø	POVRCH.ÚPR.	MAX.VELIKOST DESKY
24.G22.N71.54	740/80X80/60X390	černá	1000 X 1000

\*Skladová dostupnost na dotaz.

> PETITE N72A\_B\*

OBR.	OBJ.Č.	H/NOHA/PODSTAVA	POVRCH.ÚPR.	MAX.VELIKOST DESKY
A	24.G22.N72A.01	740/60X60/450X450	NEREZ	900 X 900
B	24.G22.N72B.01	740/60X60/450X900	NEREZ	900 X 1800

\*Skladová dostupnost na dotaz.



## CENTRÁLNÍ PODNOŽE

### > CENTRÁLNÍ PODNOŽ GG12

OBJ.Č.	POPIS	POVRCH.ÚPRAVA
24.GG12.072.10	H720/80 + talíř pr.400	chrom
24.GG12.072.54	H720/80 + talíř pr.400	černá

Skladová dostupnost na dotaz.



**MANART**  
ACCESSORI PER MOBILI  
SEDIE E TAVOLI



### > CENTRÁLNÍ PODNOŽ TELESKOPICKÁ GG06

OBJ.Č.	POPIS	POVRCH.ÚPRAVA
24.GG06.071.10	H710/60 + talíř pr.400	chrom
24.GG06.071.54	H720/80 + talíř pr.400	černá

Skladová dostupnost na dotaz.



**MANART**  
ACCESSORI PER MOBILI  
SEDIE E TAVOLI

### > CENTRÁLNÍ PODNOŽ DESIGN DVOJITÁ

OBJ.Č.	VÝŠKA	ROZMĚR PODSTAVCE	PR.NOHY	POVRCH.UPR.
G06.73FD.10.01	730	450 x 750	50	nerez



**MANART**  
ACCESSORI PER MOBILI  
SEDIE E TAVOLI

Skladová dostupnost na dotaz.





> **CENTRÁLNÍ PODNOŽ DESIGN JEDNODUCHÁ\***

OBJ.Č.	VÝŠKA	ROZMĚR PODSTAVCE	PR.NOHY	POVRCH.ÚPR.
C22.73FD.10.01	730	450 x 450	50	nerez

\*Skladová dostupnost na dotaz.



**KANCELÁŘSKÁ PODNOŽ - SADA**

OBJ.ČÍSLO	VELIKOST	POVRCH.ÚPRAVA
45.B00.700.09	H700mm	šedá
45.B00.700.54	H700mm	černá

\*sada obsahuje: 2 ks podnoží a spoj. kování



> **STOLOVÁ KONSTRUKCE DESIGN 01**

OBJ.Č.	VELIKOST	POVRCH.ÚPR.
266R.29.715X700.1	š=700, h=700mm	bez povrchové úpravy



# **KOLEČKA A NOŽKY**

## POHLEDOVÉ NOŽKY

### > NOŽKA KLOE 100 mm

PRODUKT	POPIS	POVRCH	SPECIFIKACE
17.V15B.310.10	pr.30/H100mm	chrom	kov
17.V15B.310.13	pr.30/H100mm	nikl satin	kov
17.V15B.310.21	pr.30/H100mm	nikl mat	kov



### > NOŽKA KLOE 150 mm

PRODUKT	POPIS	POVRCH	SPECIFIKACE
17.V15B.315.10	pr.30/H150mm	chrom	kov
17.V15B.315.13	pr.30/H150mm	nikl satin	kov
17.V15B.315.21	pr.30/H150mm	nikl mat	kov

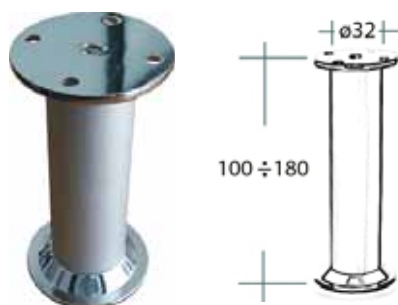

### > NOŽKA BIBLO

PRODUKT	POPIS	POVRCH
17.V23E.010.09	pr.32, H100	hliník
17.V23E.015.09	pr.32, H150	hliník

### > NOŽKA CALICE

PRODUKT	POPIS	POVRCH	SPECIFIKACE
17.V21E.095.10	výška H95	chrom	kov
17.V21E.095.21	výška H95	nikl mat	kov



### > NOŽKA STYLUS

PRODUKT	POPIS	POVRCH
17.V23E.510.09	pr.50, H100	hliník
17.V23E.515.09	pr.50, H150	hliník



### > NOŽKA TWIN R

PRODUKT	POPIS	POVRCH
17.V24E.006.09	H60, pr.40	hliník
17.V24E.008.09	H80, pr.40	hliník
17.V24E.010.09	H100, pr.40	hliník
17.V24E.015.09	H150, pr.40	hliník
17.V24E.018.09	H180, pr.40	hliník

### > NOŽKA TWIN S H60

PRODUKT	POPIS	POVRCH
17.V25E.005.43	40x40 H60	nerez
17.V25E.006.09	40x40 H60	hliník
17.V25E.006.54	40x40 H60	černá

### > NOŽKA TWIN S H100

PRODUKT	POPIS	POVRCH
17.V25E.010.09	40x40 H100	nerez
17.V25E.010.43	40x40 H100	hliník
17.V25E.010.54	40x40 H100	černá

### > NOŽKA TWIN S H120

PRODUKT	POPIS	POVRCH
17.V25E.012.09	40x40 H120	hliník

### > NOŽKA TWIN S H150

PRODUKT	POPIS	POVRCH
17.V25E.015.09	40x40 H150	hliník
17.V25E.015.43	40x40 H150	nerez
17.V25E.015.54	40x40 H150	černá



## SOKLOVÉ NOŽKY

### > ZÁKLADNÍ S PŘÍRUBOU

PRODUKT	VÝŠKA
22.002.100.50	H100
22.002.120.50	H120
22.002.150.50	H150



### > „MINI“ BEZ PŘÍRUBY

PRODUKT	VÝŠKA
22.002.L06.50	60
22.002.L08.50	80

Příruby na straně 38.



### > ZÁTĚŽOVÉ BEZ PŘÍRUBY

PRODUKT	POPIS
22.002D.10A.50	soklová nožka zátěžová H100
22.002D.12A.50	soklová nožka zátěžová H120
22.002D.15A.50	soklová nožka zátěžová H150

Příruby na straně 38.



### > SOKLOVÉ NOŽKY VOLPATO

PRODUKT	VÝŠKA
22.002V.100.50	H100
22.002V.120.50	H120
22.002V.150.50	H150

Příruby na straně 38.

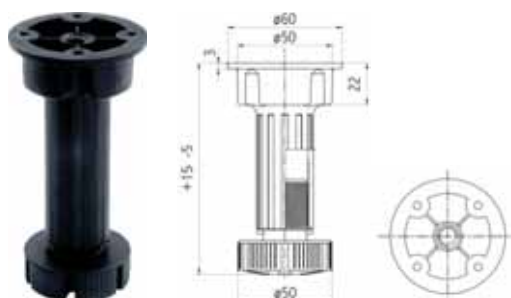

### > SOKLOVÁ NOŽKA STAVITELNÁ

OBJ.Č.	VÝŠKA	SPECIFIKACE
22.002.085.50	80-120	staviteľná



> PŘÍRUBY K SOKLOVÝM NOŽKÁM (MINI + ZÁTĚŽOVÉ)

OBJ. ČÍSLO	POPIS
A. 22.001.010.50	příruba soklové nožky ROTONDA
B. 22.001.030.50	příruba soklové nožky TRIANGOLA
C. 22.001.020.50	příruba soklové nožky QUADRA

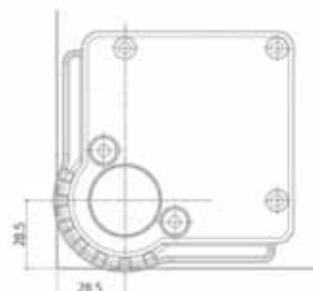
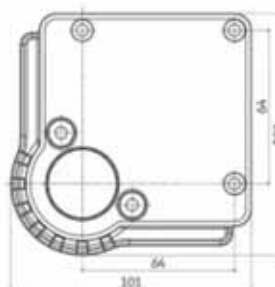
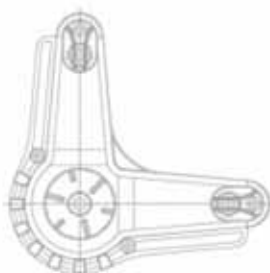
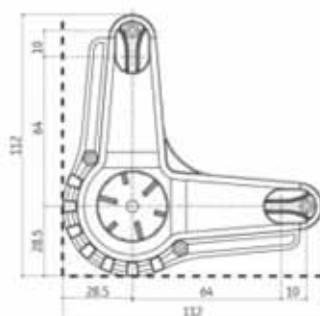
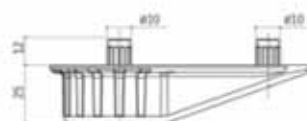
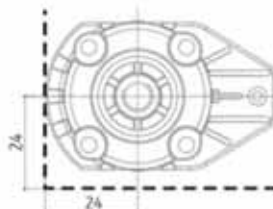
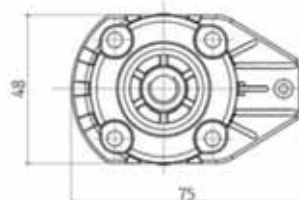
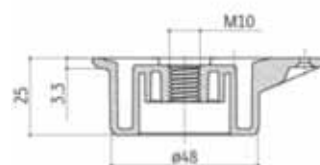



> PŘÍCHYTY SOKLOVÝCH NOŽEK  
UNIONPLAST

PRODUKT	SPECIFIKACE
24.305.050.50	k plastovému soklu
24.306.050.50	k dřevěnému soklu



> PŘÍCHYTY SOKLOVÝCH NOŽEK  
VOLPATO

PRODUKT	SPECIFIKACE
24.310V.050.50	nasouvací
24.314V.000.50	na vrut



> PŘÍCHYT SOKLOVÝCH NOŽEK  
UNIVERZÁLNÍ

PRODUKT	SPECIFIKACE
24.314.000.50	na vrut



> REGULAČNÍ PATKA

OBJ.ČÍSLO	ROZMĚRY	ODSTÍN
40.201E.2418.50	pr.24/tl.18,5	černá



> CAMAR ZÁVRTNÁ NOŽKA

OBJ.ČÍSLO	PRŮMĚR	MATER
07.0301.2850.02	50	ZINEK



> CAMAR 306 ZÁVRTNÁ NOŽKA

OBJ.ČÍSLO	ROZMĚRY	MATERIÁL
07.0320.052.02	H52, D12mm	zinek
07.0321.070.02	H70, D12mm	zinek
07.0322.120.02	H120, D12mm	zinek



> CAMAR 300 REGULAČNÍ NOŽKA

OBJ.Č.	ROZMĚRY	NOSNOST
07.0300.000.02	H30	100 kg





> NOŽKY M6 A M8

OBJ.Č.	POPIS	ROZMĚRY
40.2020.020.50	M6	pr.17mm, H20 mm
40.2020.E18.50	M8	pr.22mm, H38mm

> KLUZÁKY LEV5

OBJ.Č.	VÝŠKA	SPECIFIKACE
40.2050.017.50	H17	černý/plast
40.2050.027.50	H27	černý/plast
40.2050.044.50	H44	černý/plast

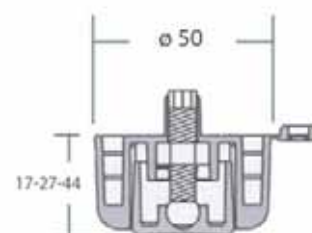

KOLEČKA



> KOLEČKA NÁBYTKOVÁ DRIVE S PLOTNIČKOU

OBJ.Č.	PRŮMĚR	ODSTÍN
41.0042.042.50	40	černá
41.0050.050.50	50	černá

> KOLEČKA NÁBYTKOVÁ DRIVE S PLOTNIČKOU A BRZDOU

OBJ.Č.	PRŮMĚR	ODSTÍN
41.0042F.042.50	40	černá
41.0050F.050.50	50	černá



> KOLEČKA ZÁTĚŽOVÁ INDUSTRY  
S PLOTNIČKOU

OBJ.Č.	PRŮMĚR	NOSNOST KG
70.M00.050.50	50	35
70.M00.075.50	75	60
70.M00.100.50	100	90



> KOLEČKA ZÁTĚŽOVÁ INDUSTRY  
S PLOTNIČKOU A BRZDOU

OBJ.Č.	PRŮMĚR	NOSNOST KG
70.MF0.050.50	50	35
70.MF0.075.50	75	60
70.MF0.100.50	100	90

> KOLEČKA ZÁTĚŽOVÁ  
TRANSPARENTNÍ S PLOTNIČKOU

OBJ.Č.	PRŮMĚR	SPECIFIKACE
40.118.035.06	35	25 kg, plot.42x42
40.118.050.06	50	35 kg, plot.42x42
40.118.075.06	75	45 kg, plot.60x60



> KOLEČKA ZÁTĚŽOVÁ  
TRANSPARENTNÍ S PLOTNIČKOU  
A BRZDOU

OBJ.Č.	PRŮMĚR	SPECIFIKACE
40.118.035F.06	35	25 kg, plot.42x42
40.118.050F.06	50	35 kg, plot.42x42
40.118.075F.06	75	45 kg, plot.60x60



A.



B.

> KOLEČKA S PLOT. POGUMOVANÁ Ø 50

OBR.	OBJ.Č.	ROZMĚRY	SPECIFIKACE
A	40.119.050.54	pr.50,38x38	bez brzdy, černá
B	40.119.050F.54	pr.50,38x38	s brzdou, černá

**LEVEL**  
THE LEVEL

> KOLEČKA PEVNÁ PLASTOVÁ

OBJ.Č.	PRŮMĚR	SPECIFIKACE
23.0717.025.05	25	černá
23.0717.030.05	30	černá

**LEVEL**  
THE LEVEL



> KOLEČKA PEVNÁ POGUMOVANÁ

OBJ.Č.	PRŮMĚR	ODSTÍN
40.0717.025.05	25 mm	černá



# **NOSIČE POLIC**

## PODPĚRKY POLIC

### > NA SKLO KOV-NYLON

OBJ.Č.: 02.0537.005.20



### > NA SKLO KOV-GUMA

OBJ.Č.: 02.0538.005.20



### > NA SKLO KOV - NYLON (VRUT)

OBJ.Č.: 02.0539.C05.20



### > NA SKLO KOV - NYLON (KOLÍK)

OBJ.Č.: 02.0539.B05.20



OBJ.Č.

POPIS

04.0617.A005.20

kolík pr. 5mm

04.0615.000.5T

podpěrka ke kolíku



### > S JEDNÍM TRNEM

OBJ.Č.: 34.0142.005.20



### > DUPLO 1

OBJ.Č.

VELIKOST

MATERIÁL

02.072.524.05

5x5.24

zinek



### > SE DVĚMA TRNY

OBJ.Č.: 34.0143.005.20



### > DUPLO 2

OBJ.Č.

VELIKOST

MATERIÁL

A. 02.072.515.05

5x3

zinek

B. 02.072.516.05

5x5

zinek

C. 02.072.517.05

5x7

nikl



A.



B.



C.

## PODPĚRY A DRŽÁKY POLIC LEONARDO

### > 120 mm (20 kg)

OBJ.Č.	BAR.PROVEDENÍ
23.0300.120.51	bílá
23.0300.120.54	černá
23.0300.120.56	šedá
23.0300.120.5H	tmavě hnědá
23.0300.120.5L	ořech
23.0300.120.73	olše
23.0300.120.C13	jasan

### > 180 mm (25 kg)

OBJ.Č.	BAR.PROVEDENÍ
23.0300.180.51	bílá
23.0300.180.54	černá
23.0300.180.56	šedá
23.0300.180.5H	tmavě hnědá
23.0300.180.5L	ořech
23.0300.180.73	olše
23.0300.180.C13	jasan

### > 240 mm (25 kg)

OBJ.Č.	BAR.PROVEDENÍ
23.0300.240.51	bílá
23.0300.240.54	černá
23.0300.240.56	šedá
23.0300.240.5H	tmavě hnědá
23.0300.240.5L	ořech
23.0300.240.73	olše
23.0300.240.C13	jasan

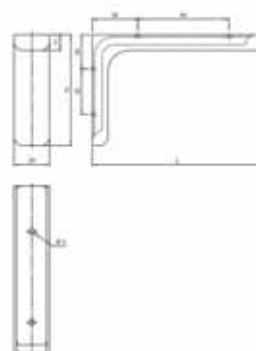

## DRŽÁKY POLIC

### > TUCANO „XS“

OBJ.Č.	VELIKOST	POVRCH.ÚPR.
07.C04.045.10	40 mm	chrom
07.C04.045.22	40 mm	nikl brouš.

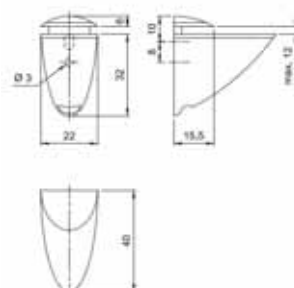

### > TUCANO „S“

OBJ.Č.	VELIKOST	POVRCH.ÚPR.
07.C03.056.09	54 mm	RALL9006
07.C03.056.10	54 mm	chrom
07.C03.056.21	54 mm	nikl mat
07.C03.056.22	54 mm	nikl brouš

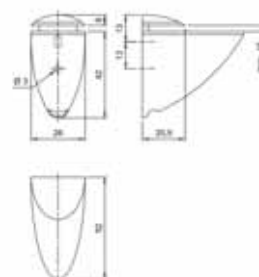



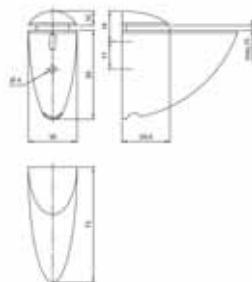

> TUCANO „M“

OBJ.Č.	VELIKOST	POVRCH.ÚPR.
07.C01.075.10	75 mm	chrom
07.C01.075.21	75 mm	nikl mat
07.C01.075.22	75 mm	nikl brouš.
07.C01.075.09	75mm	RAL 9006

> KAKADU „UNI“

OBJ.Č.	VELIKOST	POVRCH.ÚPR.
07.C09.065.22	65 mm	nikl satin

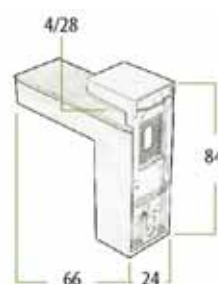

> KONZOLE SKLOPNÁ

OBJ.Č.	VELIKOST	ODSTÍN
23.2027.400.52	400X400 mm	bílá
23.2027.300.52	300X300 mm	bílá*

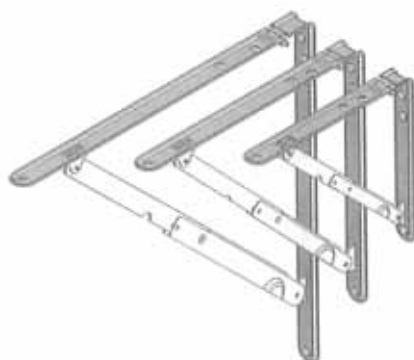
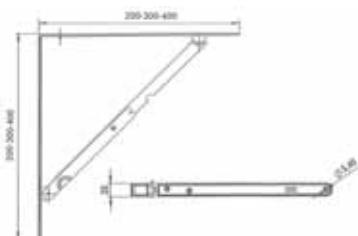

\*Skladová dostupnost na dotaz.

SKRYTÉ KONZOLE

> GOLIA

OBJ.Č.	DÉLKA
23.0305.0914.50	9 x 140
23.0305.1010.50	10 x 100
23.0305.1014.50	10 x 145
23.0305.1212.50	12 x 120
23.0305.1412.50	14 x 120
23.0305.1414.50	14 x 145
23.0305.1416.50	14 x 165



> DAVID

OBJ.Č.	SPECIFIKACE
23.0306.1111.05	d=11x110 zinek



> MN 101

OBJ.Č.	DÉLKA	MATERIÁL
23.0101.145.50	145 mm	zinek
23.0101.170.50	170 mm	zinek



> MN 114

OBJ.Č.	DÉLKA	MATERIÁL
23.0114.350.50	350 mm	zinek



> MN 121

OBJ.Č.	DÉLKA	MATERIÁL
23.0121.145.50	145 mm	zinek
23.0121.170.50	170 mm	zinek

> REKTIFIKAČNÍ KOVÁNÍ  
TYPU BYSTRICA

OBJ.Č.	ODSTÍN
06.078.000.50	bílá
06.078.000.54	černá
06.078.000.55	šedá
06.078.000.5H	tm.hnědá
06.078.000.5L	jasan
06.078.000.7U	olše
06.078.000.7Z	buk
06.078.000.4G	třešeň

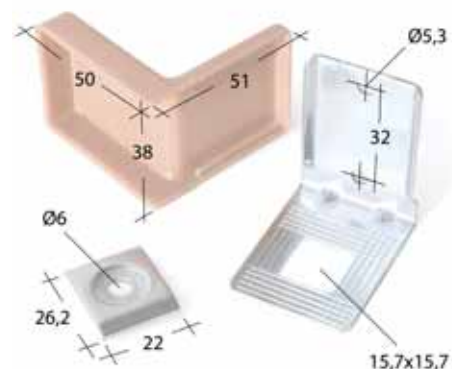



> REKTIFIKAČNÍ KOVÁNÍ  
MALÉ „BYSTŘIČKA“

OBJ.Č.	ODSTÍN
06.077.000.50	bílá
06.077.000.54	černá
06.077.000.09	sv.šedá
06.077.000.55	tm.černá
06.077.000.34	javor
06.077.000.4C	olše
06.077.000.4L	calvados
06.077.000.5L	ořech
06.077.000.7L	wenge
06.077.000.7Z	buk



> REKTIFIKAČNÍ KOVÁNÍ  
NA VRUT L/P

OBJ.Č.	ODSTÍN	SPECIFIKACE
06.084.020.52	bílá	L/P



> REKTIFIKAČNÍ KOVÁNÍ  
UNIVERZÁLNÍ

OBJ.Č.	ODSTÍN
06.088.006.50	bílá
06.088.006.5H	tm.hnědá
06.088.006.7U	sv.hnědá



> FGV 705

OBJ.Č.	POPIS
53.0705.A1.01.000	na vrut - pravá (A1)
53.0705.A1.02.000	na vrut - levá (A1)
53.07C4.A1.01.000	Krytka bílá - pravá
53.07C4.A1.02.000	Krytka bílá - levá

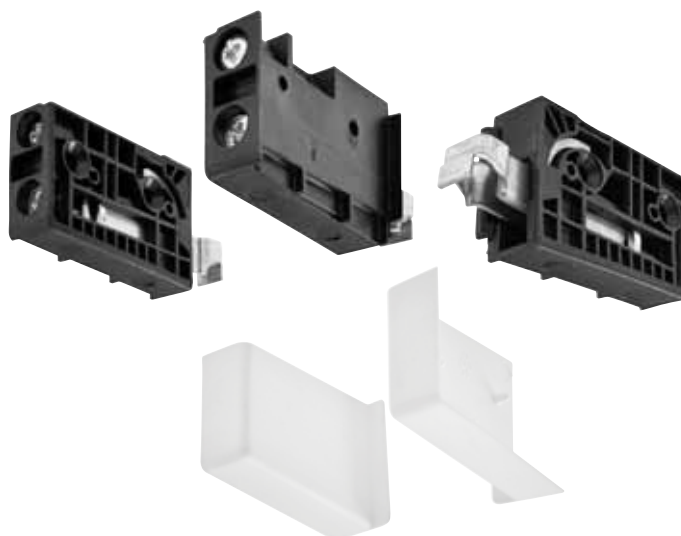

> CAMAR 806



OBJ.Č.	SPECIFIKACE	UCHYCENÍ
06.089.510.50	L+P	na hmoždinku
06.089.610.50	L+P	na vrut

> KRYTKY 806



OBJ.Č.	SPECIFIKACE	ORIENTACE
06.089.A00.52	bílá	L+P
06.089.A00.5L	ořech	L+P
06.089.A00.7U	javor	L+P
06.089.M00.13	nikl mat	L+P



> REKT. KOVÁNÍ PRO SPODNÍ SKŘÍŇKY  
CAMAR 807

OBJ.Č.	OPIS	PÁR KOVÁNÍ/OBJEDNAT:
06.089.807.00.01.00.DX.50	krytka bílá pravá	1x
06.089.807.00.01.00.SX.50	krytka bílá levá	1x
06.089.807.02.Z1.IN.DX	rekt.kování pravé	1x
06.089.807.02.Z1.IN.SX	rekt.kování levé	1x
06.089.897.AS.Z160.70	závěsný plech	2x





> ZÁVĚSNÉ LIŠTY „BARRY“

OBJ.Č.	VÝŠKA	DÉLKA
07.090.012.05	35 mm	2000
07.091.050.05	48 mm	2000



> CAMAR ZÁVĚSNÝ PLECH

OBJ.Č.	ROZMĚRY
07.091.660.05	60x28mm
07.091.110.05	110mm

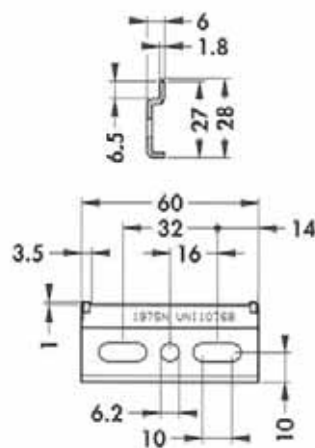

SAFARI  
LOGO  
2021

# ÚCHYTKY, VĚŠÁKY



> T35 E

OBJ.Č.	DĚLKA	POVRCH.ÚPRAVA
18.T35E.128.22	T35/128mm	nikl satén
18.T35E.160.22	T35/160mm	nikl satén
18.T35E.192.22	T35/192mm	nikl satén
18.T35E.256.22	T35/256mm	nikl satén
18.T35E.320.22	T35/320mm	nikl satén
18.T35E.416.22	T35/416mm	nikl satén
18.T35E.480.22	T35/480mm	nikl satén

> T33 E

OBJ.Č.	DĚLKA	POVRCH.ÚPRAVA
18.T33E.128.01	T33/128mm	nerez
18.T33E.160.01	T33/160mm	nerez
18.T33E.192.01	T33/192mm	nerez
18.T33E.224.01	T33/224mm	nerez
18.T33E.320.01	T33/320mm	nerez
18.T33E.432.01	T33/432mm	nerez
18.T33E.544.01	T33/544mm	nerez



> T78 E HLINÍK

OBJ.Č.	DĚLKA	POVRCH.ÚPRAVA
18.T78E.096.09	96mm	hliník elox
18.T78E.128.09	128mm	hliník elox
18.T78E.160.09	160mm	hliník elox
18.T78E.192.09	192mm	hliník elox
18.T78E.224.09	224mm	hliník elox
18.T78E.256.09	256mm	hliník elox
18.T78E.320.09	320mm	hliník elox
18.T78E.432.09	432mm	hliník elox
18.T78E.532.09	532mm	hliník elox
18.T78E.736.09	736mm	hliník elox

>> T78 E NIKL BROUŠENÝ

OBJ.Č.	DĚLKA	POVRCH.ÚPRAVA
18.T78E.096.22	96mm	nikl broušený
18.T78E.128.22	128mm	nikl broušený
18.T78E.160.22	160mm	nikl broušený
18.T78E.192.22	192mm	nikl broušený
18.T78E.224.22	224mm	nikl broušený
18.T78E.256.22	256mm	nikl broušený
18.T78E.320.22	320mm	nikl broušený
18.T78E.432.22	432mm	nikl broušený
18.T78E.532.22	532mm	nikl broušený



### > ÚCHYTKA T31 E

OBJ.Č.	DĚLKA	POVRCH.ÚPRAVA
18.T31E.096.01	96mm	nerez
18.T31E.128.01	128mm	nerez
18.T31E.160.01	160mm	nerez
18.T31E.224.01	224mm	nerez
18.T31E.320.01	320mm	nerez
18.T31E.432.01	432mm	nerez
18.T31E.544.01	544mm	nerez
18.T31E.608.01	608mm	nerez
18.T31E.736.01	736mm	nerez



### > ÚCHYTKA T32 E

OBJ.Č.	DĚLKA	POVRCH.ÚPRAVA
18.T32E.096.01	96mm	nerez
18.T32E.128.01	128mm	nerez
18.T32E.160.01	160mm	nerez
18.T32E.224.01	224mm	nerez
18.T32E.320.01	320mm	nerez
18.T32E.448.01	448mm	nerez
18.T32E.544.01	544mm	nerez
18.T32E.672.01	672mm	nerez
18.T31E.736.01	736mm	nerez

### > ÚCHYTKA T82

OBJ.Č.	DĚLKA	POVRCH.ÚPRAVA
18.T82.160.01	160mm	nerez
18.T82.192.01	192mm	nerez
18.T82.224.01	224mm	nerez
18.T82.320.01	320mm	nerez
18.T82.416.01	416mm	nerez



### > ÚCHYTKA HRAZDA

OBJ.Č.	DĚLKA	POVRCH.ÚPRAVA
18.040E.096.01	96mm	nerez
18.040E.128.01	128mm	nerez
18.040E.160.01	160mm	nerez
18.040E.224.01	224mm	nerez
18.040E.320.01	320mm	nerez
18.040E.432.01	432mm	nerez
18.040E.544.01	544mm	nerez
18.040E.608.01	608mm	nerez
18.040E.736.01	736mm	nerez





> KLEIN

HLINÍK + CHROM	HLINÍK + HLINÍK	DÉLKA V MM
DU08-0096-AL-G2	DU08-0096-AL-G6	96
DU08-0128-AL-G2	DU08-0128-AL-G6	128
DU08-0160-AL-G2	DU08-0160-AL-G6	160

> VAN GOGH

HLINÍK	NEREZ	DÉLKA V MM
DU02-0064-AL	DU02-0064-G8	64
DU02-0096-AL	DU02-0096-G8	96
DU02-0128-AL	DU02-0128-G8	128
DU02-0160-AL	DU02-0160-G8	160
DU02-0192-AL	DU02-0192-G8	192
DU02-0224-AL	DU02-0224-G8	224
DU02-0256-AL	DU02-0256-G8	256
DU02-0320-AL	DU02-0320-G8	320

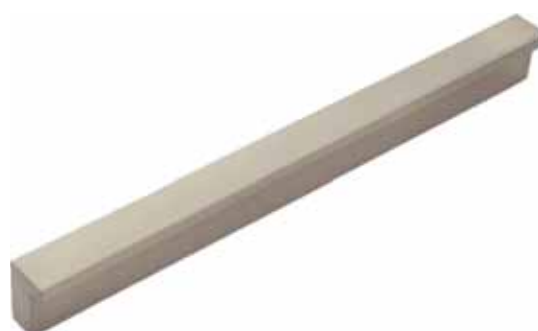

> 18.E75

HLINÍK	CHROM	DÉLKA V MM
18.E75.096.09	18.E75.096.10	96
18.E75.128.09	18.E75.128.10	128
18.E75.160.09	18.E75.160.10	160
18.E75.192.09	18.E75.192.10	192
18.E75.256.09	18.E75.256.10	256
18.E75.320.09	18.E75.320.10	320



> 18.E76

OBJ.Č.	DÉLKA V MM	POVRCH.ÚPR
18.E76.096.54	96	černá
18.E76.128.54	128	černá
18.E76.160.54	160	černá
18.E76.192.54	192	černá
18.E76.256.54	256	černá
18.E76.320.54	320	černá



### > ÚCHYTKA T54

OBJ.Č.	ROZTEČ mm	POVRCH.ÚPRAVA
18.T54.128.01	128	nerez
18.T54.160.01	160	nerez
18.T54.192.01	192	nerez
18.T54.256.01	256	nerez
18.T54.320.01	320	nerez
18.T54.416.01	416	nerez



### > ÚCHYTKA C4909

OBJ.Č.	ROZTEČ mm	POVRCH.ÚPRAVA
C4909.96	96	hliník
C4909.128	128	hliník
C4909.160	160	hliník
C4909.192	192	hliník
C4909.256	256	hliník
C4909.320	320	hliník



### > ÚCHYTKA 18.001

OBJ.Č.	ROZTEČ mm	POVRCH.ÚPRAVA
18.001.096.09	96	chrom mat
18.001.096.10	96	chrom
18.001.096.22	96	nikl satin
18.001.128.09	128	chrom mat
18.001.128.10	128	chrom
18.001.128.22	128	nikl satin





> T83

OBJ.Č.	DÉLKA	POVRCH.ÚPRAVA
18.T83.128.09	128 mm	nikl - mat
18.T83.096.09	96 mm	nikl - mat

> T81

OBJ.Č.	DÉLKA	POVRCH.ÚPRAVA
18.T81.128.22	128 mm	nikl - mat



VĚŠÁKY

> MICHELANGELO VELKÝ

OBJ.Č.	POVRCHOVÁ ÚPRAVA
DW59-G2-A	chrom
DW59-G5-A	nikl satin
DW59-G6-A	hliník

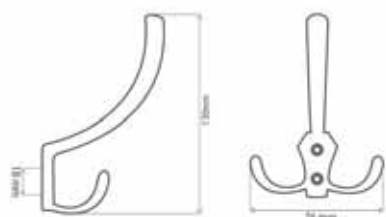

> MICHELANGELO MALÝ

OBJ.Č.	POVRCHOVÁ ÚPRAVA
DW89-G2-A	chrom
DW89-G5-A	nikl satin
DW89-G6-A	hliník



**> BOLTERO MALÝ**

OBJ.Č.	POVRCHOVÁ ÚPRAVA
DW40-G5-A	nikl - mat
DW40-G8-A	nerez



**> BOLTERO VELKÝ**

OBJ.Č.	POVRCHOVÁ ÚPRAVA
DW41-G5-A	nikl - mat
DW41-G8-A	nerez

**> GILL MALÝ**

OBJ.Č.	POVRCHOVÁ ÚPRAVA
DW12-G2-A	chrom
DW12-G5-A	nikl satin
DW12-G6-A	hliník

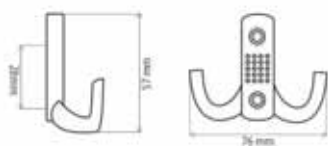

**> GILL VELKÝ**

OBJ.Č.	POVRCHOVÁ ÚPRAVA
DW11-G2-A	chrom
DW11-G5-A	nikl satin
DW11-G6-A	hliník

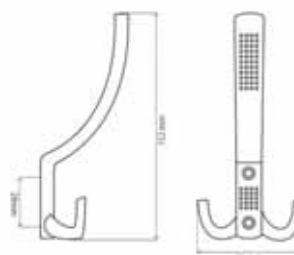



**> DONATELLO**

**OBJ.Č.**

DW19-G2-A  
DW19-G5-A  
DW19-G6-A

**POVRCHOVÁ ÚPRAVA**

chrom  
nikl satin  
hliník



**> TIZIAN MALÝ**

**OBJ.Č.**

DW16-G5-A  
DW16-G6-A

**POVRCH.ÚPRAVA**

nikl satin  
hliník elox



**> TIZIAN VELKÝ**

**OBJ.Č.**

DW17-G5-A  
DW17-G6-A

**POVRCH.ÚPRAVA**

nikl satin  
hliník elox



# **KUCHYŇSKÝ PROGRAM**

## LAHVOVNÍKY

### > VÝSUV HETTICH

OBJ.Č.	ROZMĚRY	ORIENTACE	SPEC.VÝSUVU
H26.1015.10	š.150 d.500	L	S tlum, 100%
H26.2015.10	š.150 d.500	P	S tlum, 100%
H26.1020.10	š.200 d.500	L	S tlum, 100%
H26.2020.10	š.200 d.500	P	S tlum, 100%

### > VÝSUV BLUM

OBJ.Č.	ROZMĚRY	ORIENTACE	SPEC.VÝSUVU
H28.2115.10	š.150 d.450	L	S tlum, 90%
H28.3115.10	š.150 d.450	P	S tlum, 90%
H28.2020.10	š.200 d.450	L	S tlum, 90%
H28.3020.10	š.200 d.450	P	S tlum, 90%

### > VÝSUV SALICE

OBJ.Č.	ROZMĚRY	ORIENTACE	SPEC.VÝSUVU
H27.2115.10	š.150 d.450	L	S tlum, 90%
H27.3115.10	š.150 d.450	P	S tlum, 90%
H27.2020.10	š.200 d.450	L	S tlum, 90%
H27.3020.10	š.200 d.450	P	S tlum, 90%



### > X 363, VÝSUV FGV

OBJ.Č.	ROZMĚRY	ORIENTACE	SPEC.VÝSUVU
55.X363.00.15.L00	š.150 d.490	L	S tlum, 90%
55.X363.00.15.R00	š.150 d.490	P	S tlum, 90%
55.X363.00.20.L00	š.200 d.450	L	S tlum, 90%
55.X363.00.20.R00	š.200 d.450	P	S tlum, 90%



### > JOLLY VÝSUV TEKNOLINE

OBJ.Č.	ROZMĚRY	ORIENTACE	SPEC.VÝSUVU
72.EK15.15L.10	š.150 d.500	L	S tlum, 100%
72.EK15.15R.10	š.150 d.500	P	S tlum, 100%
72.EK20.20L.10	š.200 d.500	L	S tlum, 100%
72.EK20.20R.10	š.200 d.500	P	S tlum, 100%
72.ET15.150.10	š.150 d.500	L+P	Plnovýsuv, bez TL
72.ET20.200.10	š.200 d.500	L+P	Plnovýsuv, bez TL



> INOXA DELUXE S PLNÝM DNEM

OBJ.Č.	ROZMĚRY	ORIENTACE	SPEC.VÝSUVU
H2A.1015.52.10	š.150 d.500	L	S tlum, 100%
H2A.XXXX	š.150 d.500	P	S tlum, 100%
H2A.XXXX	š.200 d.500	L	S tlum, 100%
H2A.2020.52.10	š.200 d.500	P	S tlum, 100%



VÝSUVNÉ KOŠE „300“ a „400“

> INOXA

OBJ.Č.	ROZMĚRY	ORIENTACE	SPEC.VÝSUVU
H26.0530.10	š.300 d.500	L+P	Hettich 100% s tlum.
H28.0530.10	š.300 d.500	L+P	Blum 90% s tlum.
H27.0530.10	š.300 d.500	L+P	Salice 90% s tlum.
H26.0540.10	š.400 d.500	L+P	Hettich 100% s tlum.



> FGV

OBJ.Č.	ROZMĚRY	ORIENTACE	SPEC.VÝSUVU
55.X263.00.30.T00	š.300 d.470	L+P	FGV 100% s tlum.
55.X263.00.40.T00	š.400 d.470	L+P	FGV 100% s tlum.





**INOXA COMBI'S**

OBJ.Č.	VELIKOST	ORIENTACE	SPECIFIKACE	DRÁT
H21.3110.10	viz výkres	levý	plné dno, bílá	chrom
H21.3112.10	viz výkres	pravý	plné dno, bílá	chrom
H21.3110.57	viz výkres	levý	plné dno, antracit	titan
H21.3112.57	viz výkres	pravý	plné dno, antracit	titan
H21.31XX.00	přídavný tlumič (libovolné)			



ID	TVAR	A [mm]	B [mm]	L [mm]	P [mm]
45		450	414	715	490

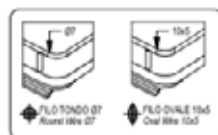
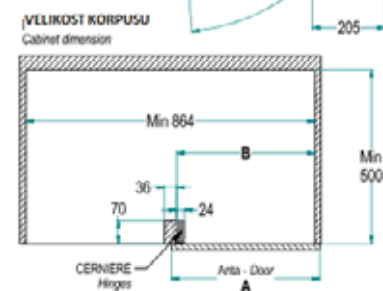
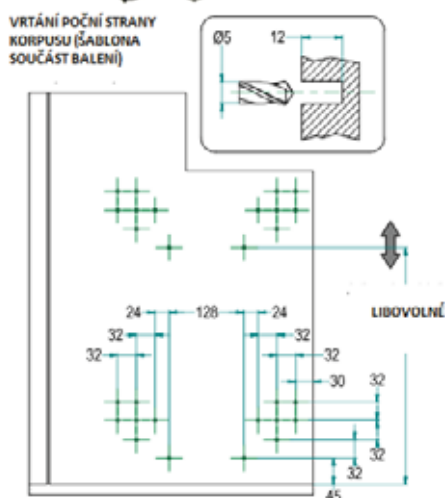
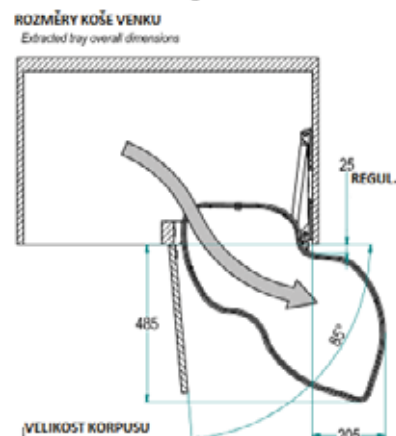
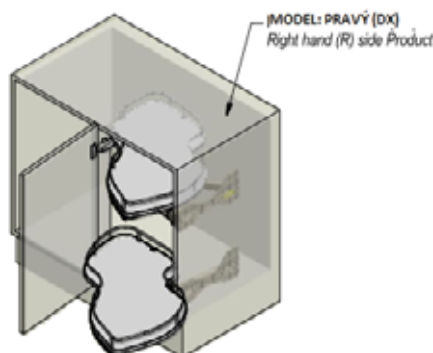

OBJ.Č.	VELIKOST	ORIENTACE	SPECIFIKACE
H21.3010.10	500/900	levý	plné dno, bílá
H21.3012.10	500/900	pravý	plné dno, bílá

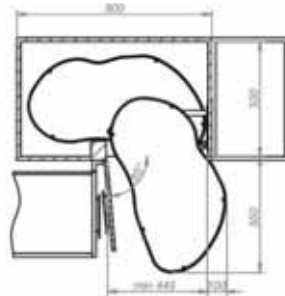

### > SLEPÝ ROH MAGICO TEKNOLINE



OBJ.Č.	ROZMĚRY	ORIENTACE	SPECIFIKACE
H21.3510.10	860x530x750	levý	drátěné dno chrom
H21.3512.10	860x530x750	pravý	drátěné dno chrom

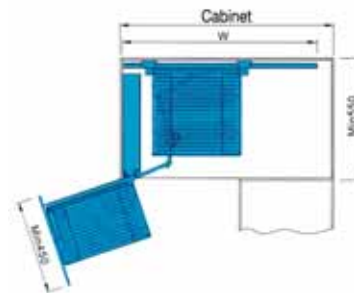
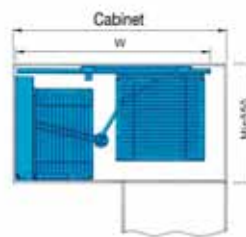

**teknoline**

### > KARUSELY

OBJ.Č.	POPIS	POVRCH. ÚPRAVA
59.103.180.10	1/2 $\phi$ 745mm 180°	chrom
59.103.270.10B	3/4 $\phi$ 710mm 270°	chrom
59.103.360.10	4/4 $\phi$ 710mm 360°	chrom

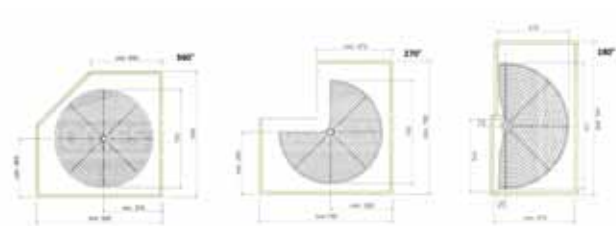
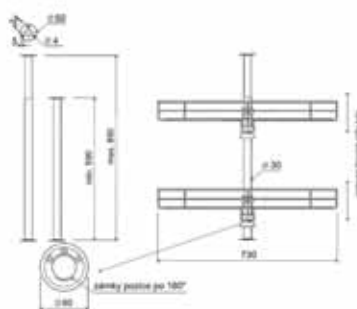



> RÁM POTR.SKŘÍNĚ S VÝSUVEM

OBJ.Č.	ROZMĚRY	NOSNOST VÝSUVU	VÝSUV
H25.4630.10	š.300 h.490 v.1650/2200	116 KG	Fulterer
H25.4640.10	š.400 h.490 v. 1650/2200	116 KG	Fulterer

> KOŠE K RÁMŮM POTR.SKŘÍNĚ  
(OBJEDNAT LIBOVOLNÝ POČET)



OBJ.Č.	POPIS	TYP
H25.6130.10	koš k rámu š.300mm	drát nebo pevné dno
H25.6140.10	koš k rámu š.400mm	drát nebo pevné dno

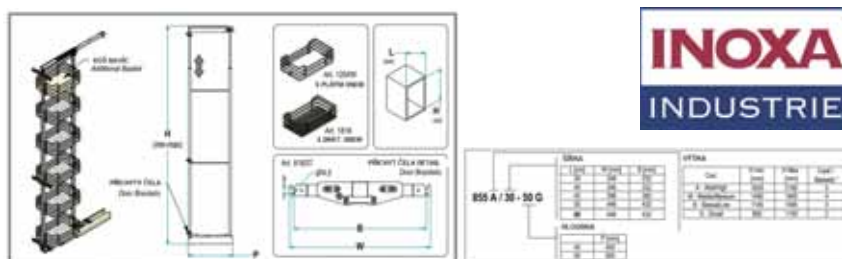

> INOXA POTRAVINOVÁ SKŘÍŇ ÚZKÁ „150“

OBJ.Č.	ROZMĚRY	VÝŠKA MIN/MAX	ORIENTACE	SPECIFIKACE	VÝSUV
H25.A515.10	š.150 d.500	1650/2200	pravá	drát nebo pevné dno*	100% s tlum, Hettich
H25.B015.10	š.150 d.500	1150/1700	levá	drát nebo pevné dno*	100% s tlum, Hettich

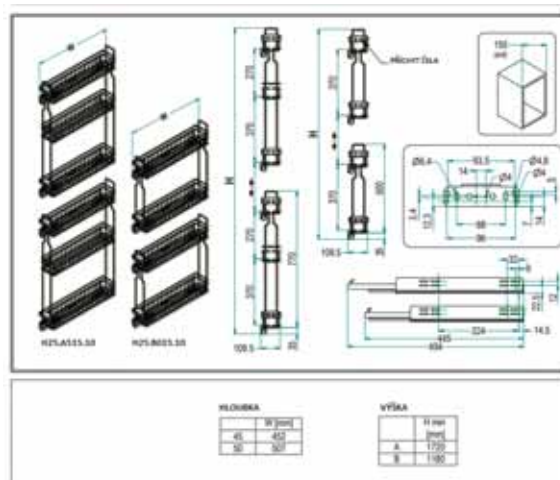

\*Požadavek drátěného nebo pevného dna je nutné specifikovat



## PŘÍBORNÍKY MODULÁRNÍ „UPPO“

### > MODUL R130

OBJ.Č.	ROZMĚRY	ODSTÍN
15.2960.3045.57	Š21/31xH41/48	antracit



### > MODUL R140

OBJ.Č.	ROZMĚRY	ODSTÍN
15.2960.4050.57	Š31/36xH41/48	antracit



### > MODUL R145

OBJ.Č.	ROZMĚRY	ODSTÍN
15.2960.4550.57	Š36/45xH41/48	antracit



### > MODUL R160

OBJ.Č.	ROZMĚRY	ODSTÍN
15.2960.6050.57	Š51/53xH41/48	antracit



> **MODUL R188**

OBJ.Č.	ROZMĚRY	ODSTÍN
15.2960.9050.57	Š81/83xH41/48	antracit



> **MODUL R195**

OBJ.Č.	ROZMĚRY	ODSTÍN
15.2960.A11.57	110/113xH41/48	antracit



> PŘÍBORNÍKY MODULÁRNÍ UNIONPLAST

OBJ.Č.	ROZMĚRY	ODSTÍN
15.2956.350.8C	300-350, 281x498	šedá
15.2956.450.8C	400-450, 402x498	šedá
15.2956.550.8C	500-550, 503x498	šedá
15.2956.600.8C	600, 553x498	šedá
15.2956.00A.8C	spojovací lišta Univerz.	šedá vroubky

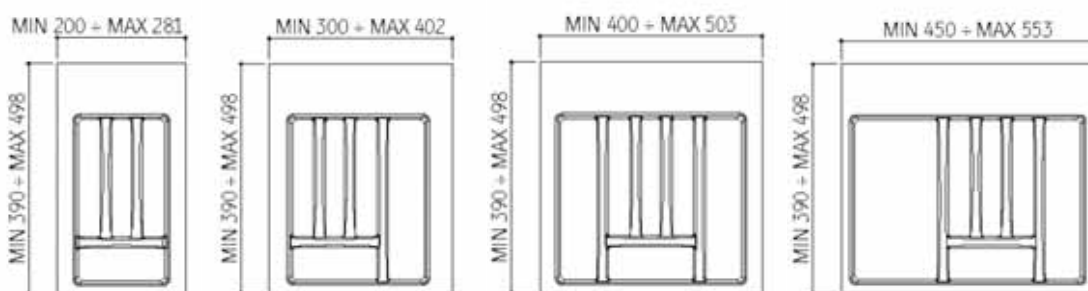

> PŘÍBORNÍKY VOLPATO

OBJ.Č.	ROZMĚRY	ODSTÍN
15.2957.270.8C	Š230/270xH380/490	tmavě šedá
15.2957.340.8C	Š300/340xH380/490	tmavě šedá
15.2957.440.8C	Š400/440xH380/490	tmavě šedá
15.2957.470.8C	Š430/470xH380/490	tmavě šedá
15.2957.540.8C	Š500/540xH380/490	tmavě šedá
15.2957.740.55	Š700/740xH380/490	tmavě šedá
15.2957.840.55	Š800/840xH380/490	tmavě šedá
15.2957.A11.55	Š1100/1140xH380/490	tmavě šedá



ODPADKOVÉ KOŠE



> ELLETIPI RING

OBJ.Č.	VÝŠKA	OBJEM L	ODSTÍN
43.0270.400.18	400mm	13	nerez
43.0270.400.50	400mm	13	bílá
43.0270.400.60	400mm	13	šedá



> SWING 2 18L

OBJ.Č.	OBJEM (L)	ODSTÍN
43.0274.350.60	18	antracit

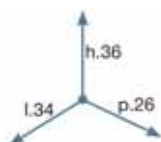

Montáž na dvířka.



> SWING 2 24L

OBJ.Č.	OBJEM (L)	ODSTÍN
43.0274.400.60	24	antracit

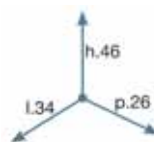

Montáž na dvířka.



> DUMPSTER 15L

OBJ.Č.	OBJEM (L)	ODSTÍN
43.0273.295.60	15	antracit

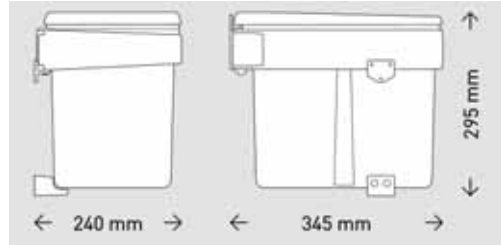

INOXA TŘÍDĚNÝ ODPAD

> KORPUS 600mm

OBJ.Č.	POPIS	VÝŠKA	KORPUS	OBJEM ODP.KOŠŮ	ODSTÍN
43.0203.60A.57	2+2	300 mm	600 mm	16+16	bílá
43.0203.64A.57	3+2	300 mm	600 mm	8+8+16	bílá

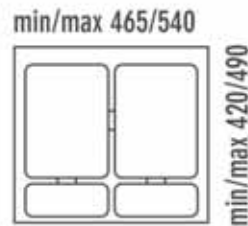

> KORPUS 800mm

OBJ.Č.	POPIS	VÝŠKA	KORPUS	OBJEM ODP.KOŠŮ	ODSTÍN
43.0203.80A.57	3+3	300 mm	800	16+16+16	antracit

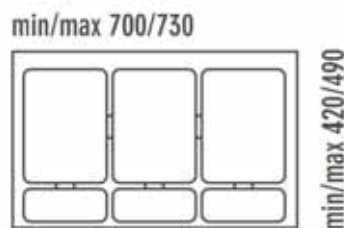





> KORPUS 900mm

OBJ.Č.	POPIS	VÝŠKA	KORPUS	OBJEM ODP.KOŠŮ	ODSTÍN
43.0203.90A.57	3+3	300 mm	800	16+16+16	antracit

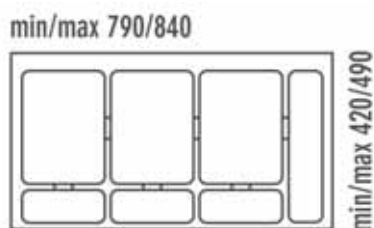

> INOXA DISCOVERY 1

OBJ.Č.	POPIS	VÝŠKA	KORPUS	OBJEM ODP.KOŠŮ	ODSTÍN	VÝSUV
43.0205.400.50	3+3	335 mm	400	16+16	bílá	quadro



> INOXA DISCOVERY 3

OBJ.Č.	POPIS	VÝŠKA	KORPUS	OBJEM ODP.KOŠŮ	ODSTÍN	VÝSUV
43.0230.020.50	3+3	335 mm	400	16+16	bílá	quadro



## > KUCHYŇSKÉ SOKLY

OBJ.Č.	VÝŠKA	DÉLKA	POVRCHOVÁ ÚPRAVA	POZN.
24.EZJO.100.59	100	4000	nerez broušená	skladem
24.EZJO.120.59	120	4000	nerez broušená	skladem
24.EZJO.150.59	150	4000	nerez broušená	skladem
24.EZJO.100.__	100	4000	hliník - br. hliník - satin	na dotaz
24.EZJO.120.__	120	4000	hliník - br. hliník - satin	na dotaz
24.EZJO.150.__	150	4000	hliník - br. hliník - satin	na dotaz

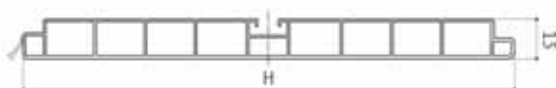

## > ODVĚTRÁVACÍ MŘÍŽKY K SOKLŮM - PVC

MODEL	OBJ.Č.	ROZMĚRY V mm	ODSTÍN
1	00.045.509.09	509*45	šedá
2	00.048.000.09	48	šedá
3	00.040.175.09	175*40	šedá

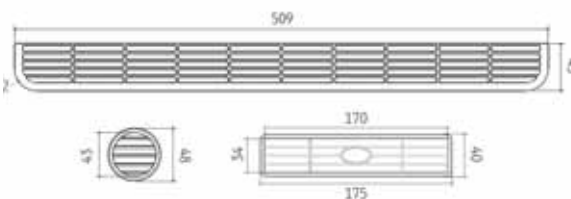
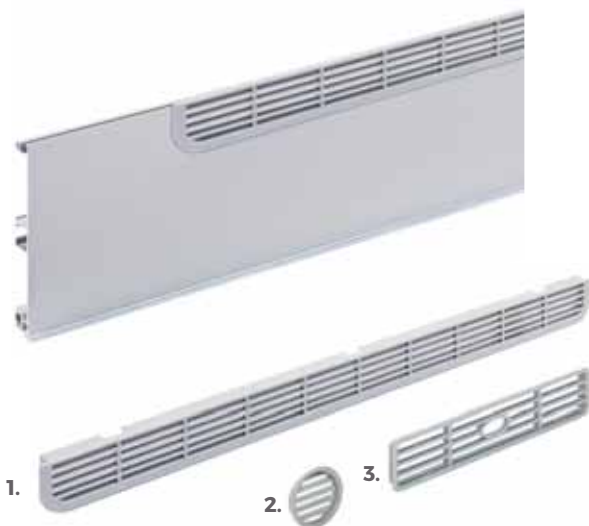

## > KUCHYŇSKÉ SOKLY - VÝSEKY

Nabízíme možnost výseků do kuchyňských soklů, které máme v nabídce.

Více informací na [www.incoll.cz](http://www.incoll.cz) nebo na zákaznickém servise.

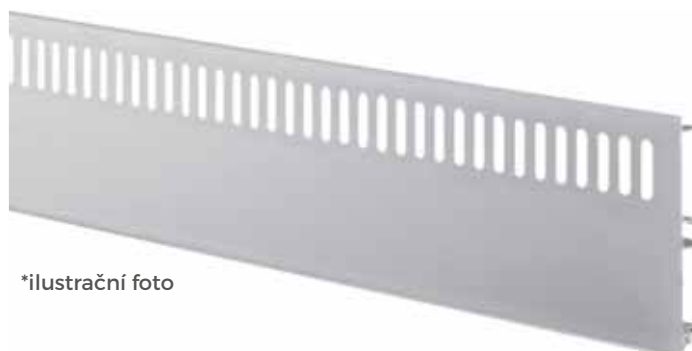

\*ilustrační foto

## ELEMENTY K SOKLŮM



### > FLEXI ROH 90°-180°

OBJ.Č.	VÝŠKA V MM	POVRCH.ÚPR.
24.EZK10.100.59	100	nerez broušená
24.EZK10.120.59	120	nerez broušená
24.EZK10.150.59	150	nerez broušená

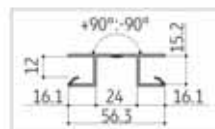

### > VNITŘNÍ A VNĚJŠÍ ROH 90°

OBJ.Č.	VÝŠKA V MM	POVRCH.ÚPR.
24.EZK6.100.59	100	nerez broušená
24.EZK6.120.59	120	nerez broušená
24.EZK6.150.59	150	nerez broušená

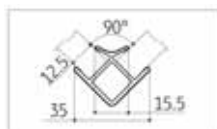

### > VNITŘNÍ A VNĚJŠÍ ROH 135°

OBJ.Č.	VÝŠKA V MM	POVRCH.ÚPR.
24.EZK7.100.59	100	nerez broušená
24.EZK7.120.59	120	nerez broušená
24.EZK7.150.59	150	nerez broušená

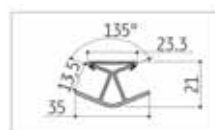

### > SPOJOVACÍ LIŠTA

OBJ.Č.	VÝŠKA V MM	POVRCH.ÚPR.
24.EZK3.100.59	100	nerez broušená
24.EZK3.120.59	120	nerez broušená
24.EZK3.150.59	150	nerez broušená

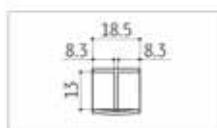
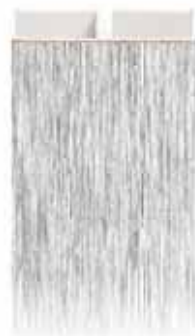

## > TĚSNÍCÍ LIŠTA SOKLOVÁ

OBJ.Č.	LAMINO	DĚLKA MM	SPECIFIKACE
24.EZK8.019E.06	16 - 18mm	3000	transparent



## TĚSNÍCÍ LIŠTY NA PRACOVNÍ DESKY

### > KONCOVÁ 28 mm

OBJ.Č.	LAMINO	DĚLKA MM	SPECIFIKACE
24.TA3.610.01	615	L+P	hliník

### > KONCOVÁ 38 mm

OBJ.Č.	LAMINO	DĚLKA MM	SPECIFIKACE
24.TA4.L60.01	615	L	hliník
24.TA4.R60.01	615	P	hliník

### > ROHOVÁ 28 mm

OBJ.Č.	LAMINO	DĚLKA MM	SPECIFIKACE
24.TB3.610.01	615	L+P	hliník

### > ROHOVÁ 38 mm

OBJ.Č.	LAMINO	DĚLKA MM	SPECIFIKACE
24.TB4.595.01	615	L+P	hliník



### > PRŮBĚŽNÁ 28 mm

OBJ.Č.	LAMINO	DĚLKA MM	SPECIFIKACE
24.TC2.60B.01	600	L+P	hliník

### > PRŮBĚŽNÁ 38 mm

OBJ.Č.	LAMINO	DĚLKA MM	SPECIFIKACE
24.TC2.65A.01	600	L+P	hliník

> PROVZDUŠNĚNÉ DNO POD LEDNICI



OBJ.Č.	POPIS	VELIKOST
24.2551.188.54	otevřené	viz TL
24.2552.188.54	zavřené	viz TL

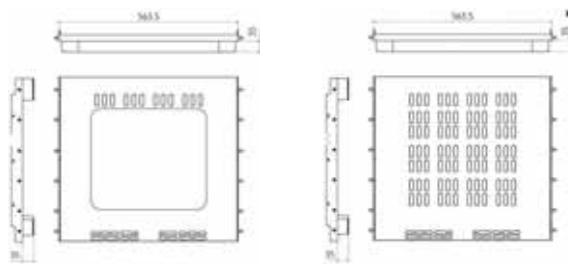

• KOMPATIBILNÍ SE ZÁTĚŽOVÝMI NOŽKAMI STR. XY



> SYPHON FLEX ZÁSUVKOVÁ ZÁDA

OBJ.Č.	ROZMĚRY	ODSTÍN
15.0000.6860.8C	L=680,H=60	šedá

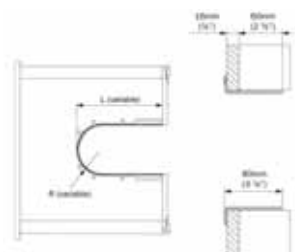

VODOVODNÍ BATERIE



> KOTA

OBJ.Č.	PRŮMĚR MM	POVRCH.ÚPR.	KARTUŠ
H71.0320.10	35	chrom	keramická

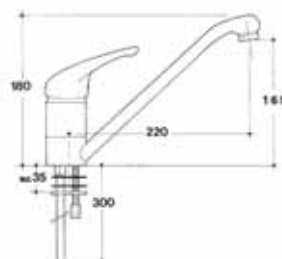

> **BARSONY\***

OBJ.Č.	POVRCH.ÚPR.	KARTUŠ
H71.0200.10	chrom	keramická

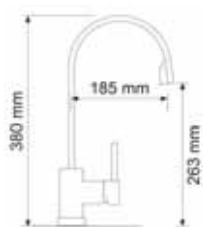

\*Skladová dostupnost na dotaz.

> **LILLY\***

OBJ.Č.	POVRCH.ÚPR.	KARTUŠ
H71.0400.10	chrom	keramická

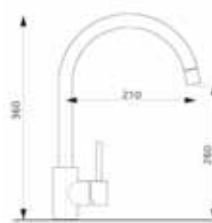

\*Skladová dostupnost na dotaz.

> **RESINA GRANIT\***

OBJ.Č.	POVRCH.ÚPR.	KARTUŠ
H71.0100.5L	pískově bílá	keramická
H71.0100.54	černá	keramická
H71.0100.55	šedá	keramická

\*Skladová dostupnost na dotaz.

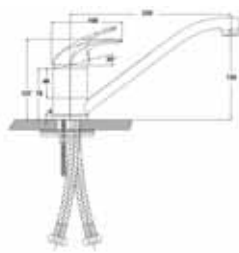

> **DÁVKOVAČ SAPONÁTU\***

OBJ.Č.	POVRCH.ÚPR.	MATERIÁL
H71.0000.10	chrom	kov + plast.nádoba



\*Skladová dostupnost na dotaz.



> KUCHYŇSKÉ DŘEZY GRANITOVÉ\*

OBJ.Č.	POVRCH.ÚPR.
H72.0100.5L	písková
H72.0100.54	černá
H71.0100.55	šedá

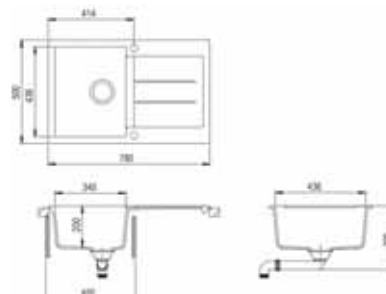

\*Skladová dostupnost na dotaz.



> PROTISKLUZOVÁ PODLOŽKA

OBJ.Č.	ROZMĚRY	ODSTÍN	VZOR
72.TPS.O48.51	1,5x480mm/20m	bílá	bublinka
72.TPS.O48.55	1,5x480mm/20m	šedá	bublinka
72.TPS.O48.57	1,5x480mm/20m	antracit	látka

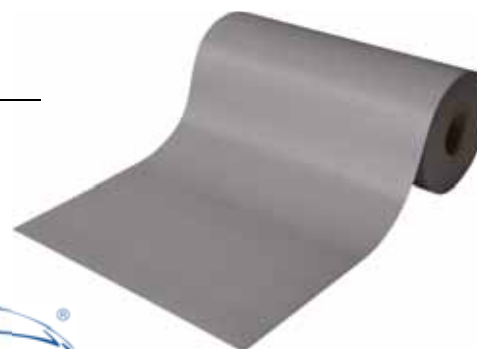
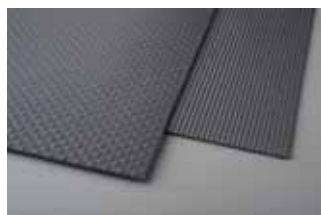

Možno objednat také 1,5 m (blister)  
(viz. strana 104).

# **VYBAVENÍ SKŘÍNÍ**



## ŠATNÍ TYČE

### > OVÁL

OBJ.Č.	ROZMĚRY	POVRCH.ÚPR.
39.010.730.10A	30x15x0,7mm/3bm	chrom



### > KRUH

OBJ.Č.	ROZMĚRY	POVRCH.ÚPR.
39.010.125.10A	25x0,7mm/3bm	chrom



## DRŽÁKY ŠATNÍCH TYČÍ

### > OVÁL

OBRÁZEK	OBJ.Č.	POPIS
A	39.0037.015.10	zavřený
B	39.0037.A15.10	průchozí
C	39.036BE.A30.20	boční



### > KRUH

OBRÁZEK	OBJ.Č.	POPIS
A	39.0037.025.10	zavřený
B	39.0037.A25.10	průchozí
C	39.0370.A25.10	Boční se šroubem



### > VÝKLOPNÉ VĚŠÁKY AMBOS

OBJ.Č.	POPIS	NOSNOST KG	SPECIFIKACE
61.E010.D75.10	LIFT 300	10	sv.šedá/chrom
61.E010.A75.10	LIFT 500	10	sv.šedá/chrom
61.E010.C75.10	LIFT 700	15	sv.šedá/chrom
61.E010.B75.10	SUPER LIFT	20	sv.šedá/chrom

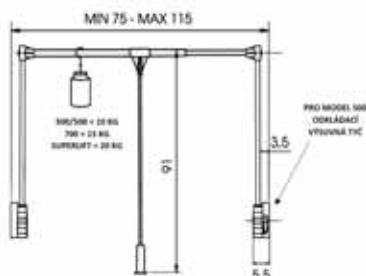

### > VÝKLOPNÉ VĚŠÁKY THE LEVEL

OBJ.Č.	ŠÍŘKA OD/DO	NOSNOST KG	SPECIFIKACE
61.E010.A45.10	450/630	10	černá/chrom
61.E010.A60.10	600/830	10	černá/chrom
61.E010.A83.10	830/1150	10	černá/chrom



### > KALHOTOVNÍK THE LEVEL

OBJ.Č.	ROZMĚRY	SPECIFIKACE
E32.1010.10	L465xW335xH105	kov-chrom, 11x rameno



### > KRAVATOVNÍK THE LEVEL

OBJ.Č.	DĚLKA	SPECIFIKACE
61.G161.500.09	460 mm	plnovýsuv

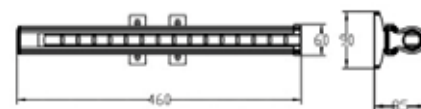



## VÝSUVNÉ VĚŠÁKY

### > E420 (JEDNODUCHÝ)

OBJ.Č.	DĚLKA	SPEC.
61.E420.025.10	250	černá/chrom
61.E420.030.10	300	černá/chrom
61.E420.035.10	350	černá/chrom
61.E420.040.10	400	černá/chrom
61.E420.045.10	450	černá/chrom
61.E420.050.10	500	černá/chrom



### > E450 (DVOJITÝ)

OBJ.Č.	DĚLKA	SPEC.
61.E450.A25.10	250	černá/chrom
61.E450.A30.10	300	černá/chrom
61.E450.A35.10	350	černá/chrom
61.E450.A40.10	400	černá/chrom
61.E450.A45.10	450	černá/chrom
61.E450.A50.10	500	černá/chrom

### > DRÁTĚNÝ KOŠ NA PRÁDLO BÍLÝ

OBJ.Č.	DO KORPUSU mm	POVRCHOVÁ ÚPRAVA
72.BP0.400.52	400	bílá

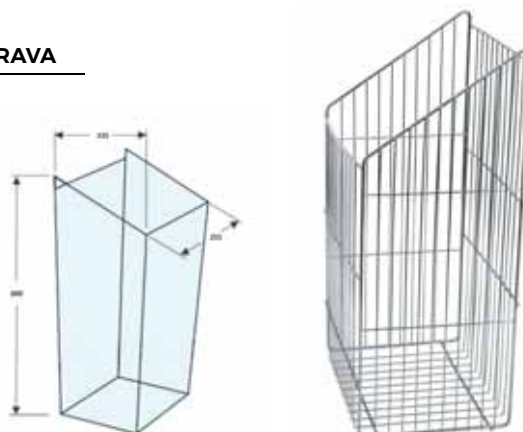

## POSUVNÝ SYSTÉM ELITE NA 1 DVEŘE

### > SADA KOVÁNÍ

OBJ.Č.	SPECIFIKACE	NOSNOST
D1.G19.01H.00	S TLUMENÍM	200 KG



### > HORNÍ NOSNÁ KOLEJNICE

OBJ.Č.	DÉLKA	SPECIFIKACE
D1.G19.202.01	2 m	HLINÍK ELOX
D1.G19.202.01	4 m	HLINÍK ELOX

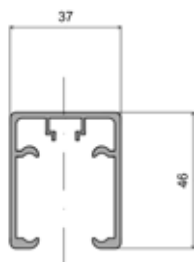

### > ÚCHYTY KOLEJNICE

OBJ.Č.	SPECIFIKACE
DM.G19.007.01	na strop
DM.G19.008.01	na stěnu

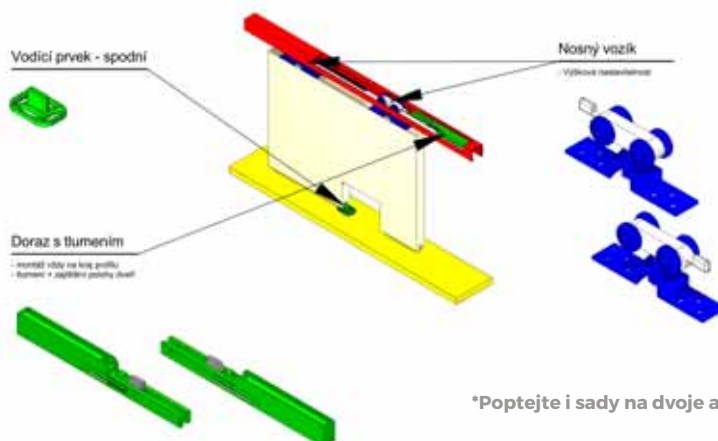
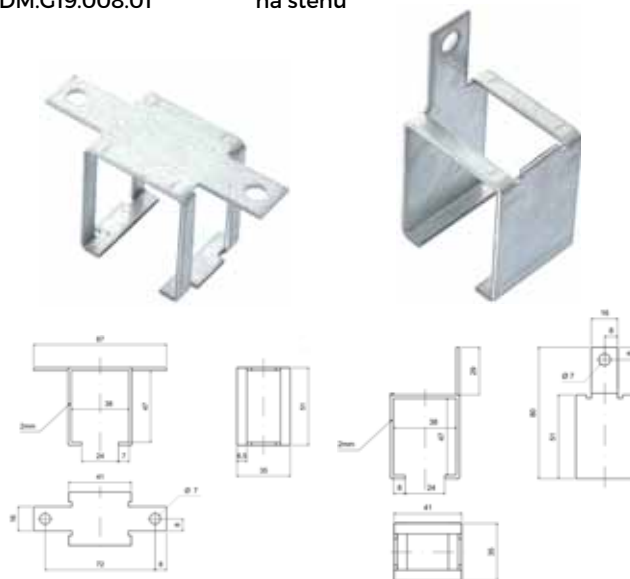

\*Poptejte i sady na dvoje a troje dveře.



# **KANCELÁŘSKÉ DOPLŇKY**

## VĚTRACÍ MŘÍŽKY

### > HLINÍKOVÉ 60mm

HLINÍK ELOX.	HLINÍK BROUŠ.	DÉLKA MM
00.1060.1000.00	00.1060.1000.22	1000
00.1060.0800.00	00.1060.0800.22	800
00.1060.0600.00	00.1060.0600.22	600
00.1060.0500.00	00.1060.0500.22	500
00.1060.0400.00	00.1060.0400.22	400
00.1060.0250.00	00.1060.0250.22	250

### > HLINÍKOVÉ 80mm

HLINÍK ELOX.	HLINÍK BROUŠ.	DÉLKA MM
00.1080.1000.00	00.1080.1000.22	1000
00.1080.0800.00	00.1080.0800.22	800
00.1080.0600.00	00.1080.0600.22	600
00.1080.0500.00	00.1080.0500.22	500
00.1080.0400.00	00.1080.0400.22	400
00.1080.0250.00	00.1080.0250.22	250



### > HLINÍKOVÉ 100mm

HLINÍK ELOX.	HLINÍK BROUŠ.	DÉLKA MM
00.1100.1000.00	00.1100.1000.22	1000
00.1100.0800.00	00.1100.0800.22	800
00.1100.0600.00	00.1100.0600.22	600
00.1100.0500.00	00.1100.0500.22	500
00.1100.0400.00	00.1100.0400.22	400
00.1100.0250.00	00.1100.0250.22	250

LEVEL  
THE LEVEL



### > PLASTOVÉ

OBJ. Č.	ROZMĚRY	ODSTÍN
00.065.0455.51	65x455	bílá
00.065.0455.68	65x455	calvados
00.065.0455.70	65x455	běžová
00.065.0455.78	65x455	hnědá

## KABELOVÉ PRŮCHODKY

### > KOVOVÉ

OBRÁZEK	OBJ.Č.	ROZMĚR	POVRCH.ÚPR.
A	40.080.080.09	80 x 80	hliník elox
B	40.160.080.09	80 x 160	hliník elox



A.

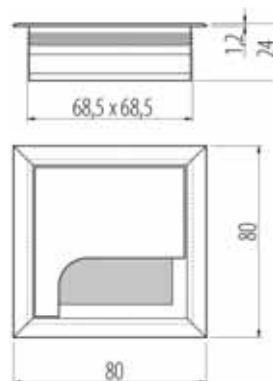

B.

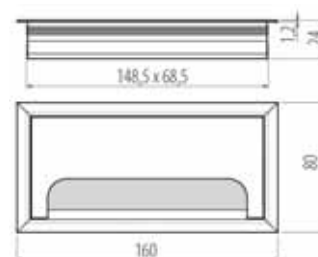

### > PLASTOVÉ Ø 60 mm

HLINÍK ELOX.	BARVA
40.360.X02.09	metalik
40.360.X02.11	šedá
40.360.X02.4G	třešeň
40.360.X02.5H	tmavě hnědá
40.360.X02.52	bílá
40.360.X02.54	černá
40.360.X02.70	buk
40.360.X02.7V	olše
40.360.X02.C13	jasan

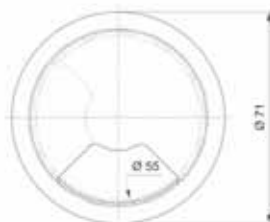





> TOČNA PLASTOVÁ DISCOCIAK

HLINÍK ELOX.

POPIS

23.0412.280.54

točna plastová pr.300mm

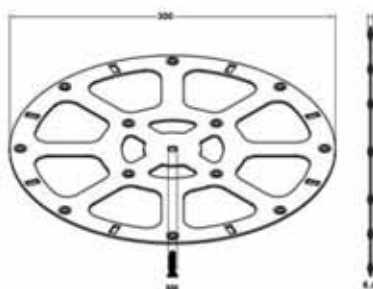

> VOZÍK NA PC

OBJ.Č.

ROZMĚRY CM

ODSTÍN

40.0440.000.50

30x15-25

sv.šedá



> VÝSUV KLÁVESNICE

OBJ.Č.

POPIS

ODSTÍN

45.PT03.P57.50

bez myši

šedá

45.PT03.P57.53

bez myši

černá

45.PT04.570.50

s myši

šedá

45.PT04.570.53

s myši

černá

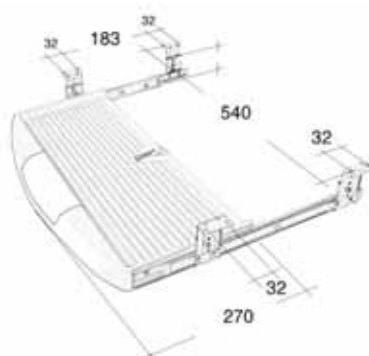

## KABELOVÉ SVODY A PŘÍCHYTY

### > BRUKO

OBJ.Č.	ROZMĚRY	SPEC.
40.K36.A02.50	44X36mm	plast, s řemínkem, šedá

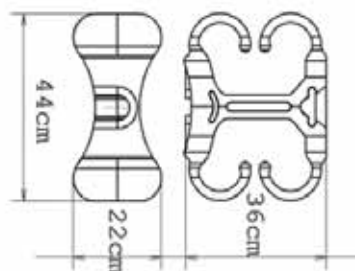

### > DROYD

OBJ.Č.	SPECIFIKACE
40.0090.T01.50	plast, černá

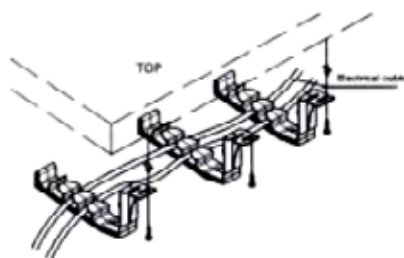



### > ZÁSUVKOVÉ VĚŽE

OBJ.Č.	SPECIFIKACE	ODSTÍN
40.T06.03F.09	3x zásuvka, 230V	RAL 9006
40.T06.03U.09	3x zásuvka + 2x USB, 230V	RAL 9006
40.T06.04F.09	4x zásuvka, 230V	RAL 9006

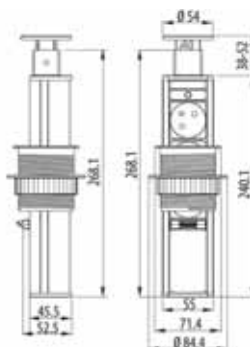

### > ZÁSUVKOVÉ BOXY

OBJ.Č.	ROZMĚRY	SPECIFIKACE 1	SPECIFIKACE 2	ODSTÍN
40.B01A.265.09	265X130 mm	3x zásuvka 230V	kabel 3m, se zemnicím kolíkem	hliník
40.B01A.265.54	265X130 mm	3x zásuvka 230V	kabel 3m, se zemnicím kolíkem	černá



SAFETY LOG 2.9

# **SPOJOVACÍ KOVÁNÍ**

11



> **KONFIRMÁTY**

OBJ.Č.	VELIKOST	SPEC.
01.014.750.05	7x50	ZINEK
01.014.770.05	7x70	ZINEK

> **EXCENTRY A TÁHLA**

OBJ.Č.	POPIS	ROZMĚRY
02.023.A16.05	excentr	pr.15 mm H 12,5
02.025.B45.05	táhlo	pr.7x45v11mm



> **ZÁVRTNÉ MATICE M6 A M8**

OBJ.Č.	POPIS
01.017.E13.01	M6x13 mm
01.017.G15.01	M8x15 mm

> **EXPANZNÍ HMOŽDINKY MOSAZ**

OBJ.Č.	POPIS
01.0051P.612.35	M6x12



> **ŠROUB VĚŽIČKA M8 ZINEK**

OBJ.Č.	POPIS
01.013.860.05	M8X60



## > SPOJOVACÍ ŠROUBY

OBJ.Č.	POPIS	SPECIFIKACE
00.013.520.20	M4x15 pr.5mm	nikl
00.013.830.20	M6x15 pr.8mm	nikl



## > IMBUS KLÍČ



OBJ.Č.	ROZMĚR	TYP
02.071.460.05	24x60mm	L4
02.071.365.05	24x60mm	L3

## > SPOJOVACÍ ŠROUBY NA PR.DESKY

OBJ.Č.	DĚLKA V MM
23.0801.070.05	65
23.0801.080.05	80*
23.0801.100.05	100
23.0801.120.05	120
23.0801.150.05	150



\*Skladová dostupnost na dotaz.

## > EUROŠROUB SE ZÁP. HLAVOU



OBJ.Č.	ROZMĚR
27.0037.A13.05	6,3x13mm



> ZIPBOLT UT SPOJ PRACOVNÍ DESKY 35X81 mm

OBJ.Č.

10500

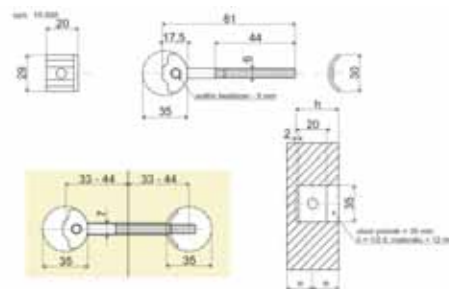

> ZIPBOLT UT SPOJ PRACOVNÍ DESKY 35X114 mm

OBJ.Č.

10600

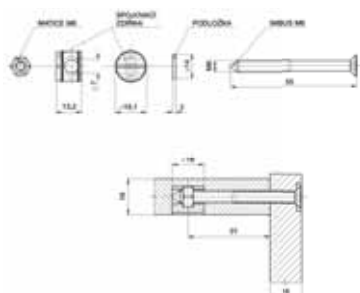
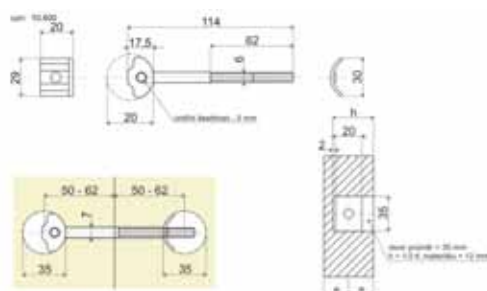

> ROHOVÉ SPOJOVACÍ KOVÁNÍ

OBJ.Č.

02.026.055.02

**VRUTY**

> CELOZÁVIT, BÍLÝ, ZÁP.HLAVA

OBJ.Č.	ROZMĚR	KS/BAL
00.003.160.05	3x16	1000
00.003.200.05	3x20	1000
00.003.300.05	3x30	1000
00.035.160.05	3,5x16	1000
00.035.200.05	3,5x20	1000
00.035.300.05	3,5x30	1000
00.040.160.05	4x16	1000
00.040.200.05	4x20	1000
00.040.350.05	4x35	1000
00.040.400.05	4x40	500
00.040.450.05	4x45	400
00.040.500.05	4x50	500
00.040.600.05	4x60	400
00.005.160.05	5x16	1000



## > CELOZÁVIT, ŽLUTÝ, ZÁP.HLAVA

OBJ.Č.	ROZMĚR	KS/BAL
00.003.160.21	3x16	1000
00.030.200.21	3x20	1000
00.030.300.21	3x30	1000
00.035.160.21	3,5x16	1000
00.035.200.21	3,5x20	1000
00.035.300.21	3,5x30	1000
00.040.160.21	4x16	1000
00.040.200.21	4x20	1000
00.040.350.21	4x35	1000
00.040.400.21	4x40	500
00.040.450.21	4x45	400
00.040.500.21	4x50	500
00.040.600.21	4x60	400
00.005.160.21	5x16	1000



## > CELOZÁVIT, ŽLUTÝ, ZÁP.HLAVA, TORX

OBJ.Č.	ROZMĚR	KS/BAL
00.035.160.21T	3,5x16	1000
00.040.300.21T	4x30	1000

## ÚHELNÍKY

### > ÚHELNÍK S PROLISEM BÍLÝ ZINEK

OBJ.Č.	ROZMĚRY
23.0737.025.05	20 x 20 mm
23.0737.030.05	30 x 30 mm
23.0737.040.05	40 x 40 mm
23.0737.050.05	50 x 50 mm
23.0737.060.05	60 x 60 mm
23.0737.080.05	80 x 80 mm



### > ÚHELNÍKY (ROHY) PLASTOVÉ 22 mm A 35 mm



OBJ.Č. 22 mm	OBJ.Č. 35 mm	SPEC.
09.000.020.4G	09.000.035.4G	calvados
09.000.020.51	09.000.035.51	bílá
09.000.020.54	09.000.035.54	černá
09.000.020.55	09.000.035.55	šedá
09.000.020.68	09.000.035.68	třešeň
09.000.020.69	09.000.035.69	buk sv.
09.000.020.71	09.000.035.71	buk tm.
09.000.020.78	09.000.035.78	hnědá



**POSTELOVÉ KOVÁNÍ**

> **MODEL 612**

OBJ.Č.	POPIS
23.0612.130.02	sada 8 ks, zinek

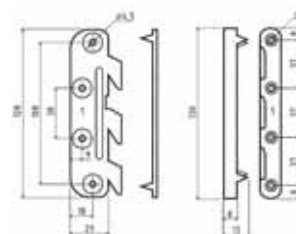

> **MODEL 610**

OBR.	OBJ.Č.	POPIS
A	23.0610.002.05	Krátký úhelník, zinek
B	23.0610.E03.05	dlouhý úhelník, zinek

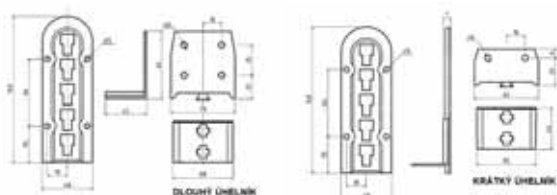

> **MODEL 605**

OBJ.Č.	POPIS
23.0605.002.05	zinek



> MECHANISMUS OTEVÍRÁNÍ POSTELE

OBJ.Č.	POPIS
38.MLB.D13.09	(dvoulůžko)
38.MLB.S13.09	(1 lůžko)



> VÝKLOPNÁ MECHANIKA POSTELE  
(POSTEL VE SKŘÍNI)

OBJ.Č.	POPIS
38.MLA.105.62	(nosnost 140 kg)
38.MLA.107.62	(nosnost 100 kg)

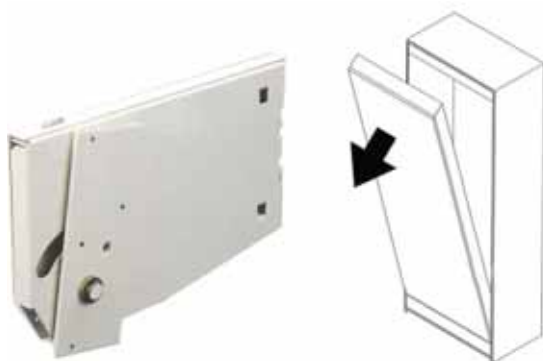

> PŘÍCHYTY STOLOVÉ NOHY ROHOVÉ

OBJ.Č.	ROZMĚRY	SPECIF.
23.0603.064.05	malý 60x64x16	zinek
23.0603.108.05	velký 108X60X36	zinek

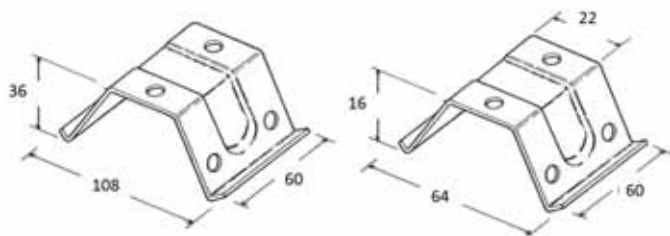

**ZÁMKY**

**> CENTRÁLNÍ**

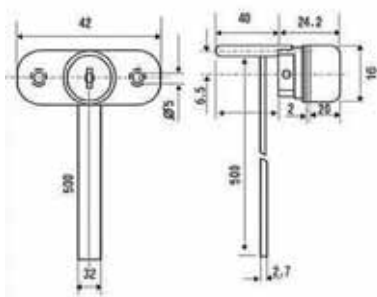

OBJ.Č.	POPIS
12.171.070.20	600mm, 4x zásuvka

**> EASY**

OBJ.Č.	POPIS
12.171.E40.20	cyklindrický 40x40



**easy**

**> SISO\***

OBJ.Č.	POPIS
12.171.S85.10	40x40 pr.19mm



\*Skladová dostupnost na dotaz.



## SAMOLEPÍCÍ KRYTKY KONFIRMÁTU

### > Ø 13 mm

(vzorkovník s krytkami žádejte u svých obchodních zástupců)

OBJ.Č.	DEKOR	OBJ.Č.	DEKOR	OBJ.Č.	DEKOR
09.0040.013.06	K POTISKU	09.0040.013.8K	BŘÍZA SVĚTLÁ	09.0040.013.59	LIMBA SVĚTLÁ
09.0040.013.51	BÍLÁ HLADKÁ	09.0040.013.70	BUK	09.0040.013.60	LIMBA TMAVÁ
09.0040.013.5U	BÍLÁ PERLA	09.0040.013.75	BUK SVĚTLÝ	09.0040.013.9R	LÍPA BÉŽOVÁ
09.0040.013.52	BÍLÁ SOFT	09.0040.013.7F	DUB ANTIK	09.0040.013.9P	LÍPA ŠEDÁ
09.0040.013.47	SLONOVÁ KOST	09.0040.013.7D	DUB BĚLENÝ	09.0040.013.7S	MAHAGON
09.0040.013.46	VANILKA	09.0040.013.9N	DUB BÉŽOVOBÍLÝ	09.0040.013.7P	MAKASAR
09.0040.013.5M	KRÉMOVÁ	09.0040.013.8P	DUB BÍLÝ	09.0040.013.9A	MODŘÍN SVĚTLÝ
09.0040.013.10	CHROM	09.0040.013.7B	DUB FERRARA	09.0040.013.C3	MODŘÍN TMAVÝ
09.0040.013.1G	HLINÍK BROUŠENÝ	09.0040.013.67	DUB RUSTIKÁL	09.0040.013.68	MORGANA
09.0040.013.23	NEREZ BROUŠENÁ	09.0040.013.8T	DUB SEPPIA	09.0040.013.48	MOŘSKÁ ŘASA
09.0040.013.09	RAL9006	09.0040.013.73	DUB SOFT	09.0040.013.7U	OLŠE
09.0040.013.45	BÉŽOVÁ ŠEĎ	09.0040.013.9C	DUB SONOMA 1	09.0040.013.77	OŘECH
09.0040.013.49	ŠEDÁ BÍLÁ	09.0040.013.9M	DUB SONOMA 2	09.0040.013.7X	OŘECH ČERVENÝ
09.0040.013.55	ŠEDÁ SVĚTLÁ	09.0040.013.8M	DUB TMAVÝ	09.0040.013.1D	OŘECH LÍSKOVÝ
09.0040.013.56	ŠEDÁ TMAVÁ	09.0040.013.8S	DUB VZOROVANÝ	09.0040.013.7J	OŘECH SVĚTLÝ
09.0040.013.8C	ŠEDÁ	09.0040.013.2C	DUB ZLATOHNĚDÝ	09.0040.013.5H	OŘECH TMAVÝ
09.0040.013.54	ČERNÁ MAT	09.0040.013.78	HNĚDÁ TMAVÁ	09.0040.013.7T	TEAK
09.0040.013.5Z	ČERNÁ STRUKTURA	09.0040.013.7Z	JABLOŇ	09.0040.013.8H	TRAMA 1 BÉŽOVÁ
09.0040.013.HN	HNĚDOČERNÁ	09.0040.013.C13	JASAN	09.0040.013.8C	TRAMA 1 HNĚDÁ
09.0040.013.CE	ČERVENÁ	09.0040.013.C01	JASAN TMAVÝ	09.0040.013.8F	TRAMA 1 SVĚTLÁ
09.0040.013.BD	ČERVENÁ BORDO	09.0040.013.7V	JAVOR	09.0040.013.9K	TRAMA 2 BÉŽOVÁ
09.0040.013.5D	LILLA	09.0040.013.7W	JAVOR TMAVÝ	09.0040.013.9H	TRAMA 2 SVĚTLE ŠEDÁ
09.0040.013.RU	RŮŽOVÁ	09.0040.013.9B	JILM BĚLENÝ	09.0040.013.9J	TRAMA 2 TMAVĚ ŠEDÁ
09.0040.013.8D	ZELENÁ	09.0040.013.9E	JILM BÉŽOVÝ	09.0040.013.7A	TŘEŠEŇ
09.0040.013.ZM	ZELENÁ MILITARY	09.0040.013.44	JILM BÍLOŠEDÝ	09.0040.013.7E	TŘEŠEŇ MERANO
09.0040.013.ZL	ŽLUTÁ	09.0040.013.9C	JILM HNĚDOBÉŽOVÝ	09.0040.013.4G	TŘEŠEŇ SVĚTLÁ
09.0040.013.ZH	ŽLUTÁ HOŘČICE	09.0040.013.9D	JILM BÉŽOVOŠEDÝ	09.0040.013.4L	TŘEŠEŇ TMAVÁ
09.0040.013.7H	BOROVICE	09.0040.013.9L	JILM HNĚDOŠEDÝ	09.0040.013.7L	WENGHE
09.0040.013.8R	BOROVICE SVĚTLÁ	09.0040.013.9F	JILM TMAVÝ	09.0040.013.7G	WENGHE ŠEDÁ
09.0040.013.79	BOROVICE TMAVÁ	09.0040.013.6I	LIMBA KLASIK	09.0040.013.7I	ZEBRANO
09.0040.013.8J	BŘÍZA			09.0040.013.72	ZEBRANO HAVANA

### > Ø 20 mm

OBJ.Č.	DEKOR	OBJ.Č.	DEKOR	OBJ.Č.	DEKOR
09.0040.020.51	BÍLÁ HLADKÁ	09.0040.020.7D	DUB BĚLENÝ	09.0040.020.C13	JASAN
09.0040.020.55	ŠEDÁ SVĚTLÁ	09.0040.020.9C	DUB	09.0040.020.70	BUK
09.0040.020.54	ČERNÁ MAT	09.0040.020.2C	DUB SONOMA 2		

Ø	9 MM	13 MM	16 MM	20 MM	25 MM	30 MM	35 MM	40 MM
MIN.ODBĚR / KS	3000	1000	1000	150	720	480	360	180
POČET KRYTEK NA PLATÍČKU	60	20	20	15	12	8	6	3
POČET KS KRYTEK V KRABICI	60	20	20	15	12	8	6	3
SKLADEM(S)/OBJEDNÁVKA(O)*	60	20	20	15	12	8	6	3

\* dekory Ø krytek na objednávku jsou shodné s dekory Ø 13 mm

\*\* skladem 8 dekorů - viz vzorkovník, ostatní na objednávku





### > SAMOLEPÍČÍ KRYTKY

OBJ.Č.	ROZMĚR/POPIS	BARVA	POČET KS V BLISTRU
ITFM 038 50	ø 13	BÍLÁ 11164	20
ITFM 042 50	ø 13	ČERNÁ 657	20
ITFM 054 50	ø 13	TŘEŠEŇ 9049	20
ITFM 058 50	ø 13	OŘECH 6045	20
ITFM 065 50	ø 13	ROVERE 4569	20
ITFM 067 50	ø 13	WENGE 994 PLR2	20

### > KLUZÁKY

OBJ.Č.	ROZMĚR/POPIS	BARVA	POČET KS V BLISTRU
ITSB 002 25	HŘEBÍK + FILC ø 20	HNĚDÁ	8
ITSB 004 25	FELTRO CHIDO ø 24	HNĚDÁ	8
ITSB 005 25	HŘEBÍK + FILC ø 28	HNĚDÁ	8
ITSB 015 25	ŠROUB + FILC ø 20	HNĚDÁ	8
ITSB 016 25	ŠROUB + FILC ø 24	HNĚDÁ	8
ITSB 017 25	ŠROUB + FILC ø 28	HNĚDÁ	8
ITSA 002 25	KOV + GUMA (CHROM) ø 20	CHROM	8
ITSA 004 25	KOV + GUMA (CHROM) ø 25	CHROM	8
ITSA 006 25	KOV + GUMA (CHROM) ø 30	CHROM	8
ITSC 005 25	HŘEBÍK + PLAST ø 20	HNĚDÁ	8
ITSC 007 25	HŘEBÍK + PLAST ø 25	HNĚDÁ	8
ITSC 008 25	HŘEBÍK + PLAST ø 30	HNĚDÁ	8



### > KLUZÁKY TEFLON

OBJ.Č.	ROZMĚR/POPIS	BARVA	POČET KS V BLISTRU
ITSD 018 25	TEFLIFIT SAMOLEP ø 20	ŠEDÁ	8
ITSD 019 25	TEFLIFIT SAMOLEP ø 25	ŠEDÁ	8
ITSD 020 25	TEFLIFIT SAMOLEP ø 30	ŠEDÁ	8
ITSD 022 25	TEFLIFIT SAMOLEP ø 50	ŠEDÁ	4
ITSD 028 25	TEFLIFIT SAMOLEP ø 70	ŠEDÁ	4
ITSD 024 25	TEFLIFIT SAMOLEP 24X100	ŠEDÁ	4
ITSD 205 25	TEFLIFIT SE ŠROUBEM ø 19	ŠEDÁ	8
ITSD 206 25	TEFLIFIT ŠROUB ø 25	ŠEDÁ	8
ITSD 207 25	TEFLIFIT ŠROUB ø 30	ŠEDÁ	8
ITSD 033 25	TEFLIFIT FUST SAMOLEP ø 17	ŠEDÁ	16
ITSD 034 25	TEFLIFIT FUST SAMOLEP ø 22	ŠEDÁ	12
ITSD 035 25	TEFLIFIT FUST SAMOLEP ø 28	ŠEDÁ	6



## > SAMOLEPÍCÍ ČOČKY DORAZOVÉ

OBJ.Č.	PR. X H/MM	TVAR
09.0034.110.06	10 x 1,5	kruh
09.0034.207.06	7 x 1,5	kruh
09.0034.310.06	10 x 3	kruh
09.0038.000.50	13 x 4	kruh



## > FILCOVÉ PODLOŽKY



OBJ.Č.	ROZMĚR/POPIS	BARVA	POČET KS V BLISTRU
ITFB 612 50	∅ 9	BÍLÁ	32
ITFB 504 50	∅ 16	BÍLÁ	15
ITFB 512 50	∅ 20	BÍLÁ	10
ITFB 520 50	∅ 24	BÍLÁ	8
ITFB 528 50	∅ 28	BÍLÁ	6
ITFB 540 50	∅ 35	BÍLÁ	4
ITFB 544 50	∅ 40	BÍLÁ	2
ITFB 552 50	∅ 50	BÍLÁ	2
ITFB 556 50	20X20	BÍLÁ	10
ITFB 560 50	25X25	BÍLÁ	8
ITFB 564 50	25X50	BÍLÁ	6
ITFB 604 50	30X30	BÍLÁ	4
ITFB 584 50	100X100	BÍLÁ	1
ITFB 613 50	∅ 9	HNĚDÁ	32
ITFB 505 50	∅ 16	HNĚDÁ	15
ITFB 513 50	∅ 20	HNĚDÁ	10
ITFB 521 50	∅ 24	HNĚDÁ	8
ITFB 529 50	∅ 28	HNĚDÁ	6
ITFB 541 50	∅ 35	HNĚDÁ	4
ITFB 545 50	∅ 40	HNĚDÁ	2
ITFB 553 50	∅ 50	HNĚDÁ	2
ITFB 557 50	20X20	HNĚDÁ	10
ITFB 561 50	25X25	HNĚDÁ	8
ITFB 565 50	30X30	HNĚDÁ	6
ITFB 605 50	25X50	HNĚDÁ	4
ITFB 585 50	100X100	HNĚDÁ	1

## > SAMOLEPÍCÍ ČOČKY

OBJ.Č.	ROZMĚR/POPIS	BARVA	POČET KS V BLISTRU
ITPA005/50	7X1,5	TRANSP.	25
ITPA025/50	10X3	TRANSP.	25
ITPA039/50	13X4	TRANSP.	20
ITPA 076 50	13X7,5	TRANSP.	20
ITPA 057 50	19X9,5	TRANSP.	9
ITPA 065 50	20,5X20,5X7,5	TRANSP.	9
ITPA 073 50	20X20X13,2	TRANSP.	9
ITPA 069 50	22,3X10,1	TRANSP.	9
ITPU 008 50	85X110	TRANSP.	1
ITFQ 001 50	∅ 9	ČERNÁ	45
ITFQ 005 50	∅ 14	ČERNÁ	20
ITFQ 029 50	85X100	ČERNÁ	1





### > KLUZÁK PVC + FILC

OBJ.Č.	ROZMĚR/POPIS	BARVA	POČET KS V BLISTRU
ITPS 007 25	KLUZÁK PVC + FILC ø 12	TRANSP.	8
ITPS 008 25	KLUZÁK PVC + FILC ø 16	TRANSP.	8
ITPS 009 25	KLUZÁK PVC + FILC ø 18	TRANSP.	8
ITPS 010 25	KLUZÁK PVC + FILC ø 20	TRANSP.	8
ITPS 011 25	KLUZÁK PVC + FILC ø 22	TRANSP.	4
ITPS 012 25	KLUZÁK PVC + FILC ø 25	TRANSP.	4

### > HOBBY

OBJ.Č.	ROZMĚR/POPIS	BARVA	POČET KS V BLISTRU
ITK001.25	oboustranná lep. páska h19mm x 1500mm (1.)	BÍLÁ	1
ITK019.50	oboustranně lepící štítky pr.20mm (2.)	BÍLÁ	12
ITZA001.12	protiskluzová podložka na schody samolep 19mmx6000mm (3.)	ČERNÁ	1
ITRL001.25	protiskluzová podložka 480mm x 1500mm (4.)	ŠEDÁ	1
ITRL003.25	protiskluzová podložka 480mm x 1500mm	BÍLÁ	1
ITES004.74	Practical way PRODEJNÍ STOJAN malý (zdarma ke zboží) (4.)	INCOLL	1



\*Stojan zdarma!



### > KOLÍKY

OBJ.Č.	VELIKOST	DŘEVINA
00.000.006.35	6x35	buk
00.000.008.30	8x30	buk
00.000.008.35	8x35	buk
00.000.008.40	8x40	buk
00.000.010.40	10x40	buk
00.000.010.50	10x50	buk



### > KOLÍKOVÉ TYČE

HLADKÁ	VROUBKOVANÁ	Ø mm	DÉLKA M	DŘEVINA
00.000.006.11	00.000.006.10	6	1	buk
00.000.008.11	00.000.008.10	8	1	buk
00.000.010.11	00.000.010.10	10	1	buk
00.000.012.11	00.000.012.10	12	1	buk
00.000.014.11	00.000.014.10	14	1	buk
00.000.016.11	00.000.016.10	16	1	buk
00.000.018.11	00.000.018.10	18	1	buk
00.000.020.11	00.000.020.10	20	1	buk
00.000.025.11	/	25	1	buk
00.000.030.11	/	30	1	buk

### > LAMELKY

OBJ.Č.	Č.OZNAČ.	DŘEVINA
00.000.010.00	10	bříza
00.000.020.00	20	bříza







# **PLOŠNÉ MATERIÁLY**

## MDF DESKY LESK A SUPER MAT

(vzorkovník dekorů zdarma žádejte na zákaznickém servisu)

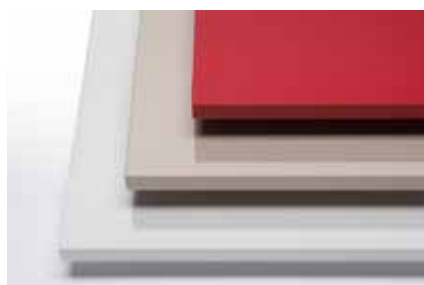

### > ACRYL VISION VYSOKÝ LESK

MDF desky s akrylátovou vrstvou o tloušťce 1,4 mm jsou jedny z nejkvalitnějších na trhu. Desky standardně dodáváme jednostranně potažené akrylátovou fólií ve vysokém lesku, protitah je pak tvořen standardní fólií, ale ve stejném dekoru jako „lícová“ strana. Desky oboustranně potažené akrylátovou fólií jsou standardním sortimentem výrobce, v případě zájmu lze objednat. Rozměry desek jsou 1300 x 2800 mm, tloušťka desky je 18,2 mm. K deskám dodáváme hrany identického dekoru, hrany jsou italské výroby o tloušťce od 1 do 2 mm - dle specifikace zákazníka.



**BÍLÁ**  
77.G28.018.51



**SLONOVÁ KOST**  
77.G28.018.49



**CAPPUCCINO**  
77.G28.018.4A



**MOKKA**  
77.G28.018.87



**ŠEDÁ**  
77.G28.018.27



**ČERNÁ HG**  
77.G28.018.54



### > PET SUPER MAT

MDF desky s PET vrstvou, certifikované a zdravotně nezávadné s ochranou proti otiskům prstů. Desky standardně dodáváme jednostranně potažené PET fólií, protitah je pak tvořen standardní fólií, ale ve stejném dekoru jako „lícová“ strana. Desky oboustranně potažené pet fólií jsou standardním sortimentem výrobce, v případě zájmu lze objednat. Rozměry desek jsou 1300 x 2800 mm, tloušťka desky je 18,15 mm. K deskám dodáváme hrany identického dekoru, hrany jsou italské výroby o tloušťce od 1 do 2 mm - dle specifikace zákazníka.

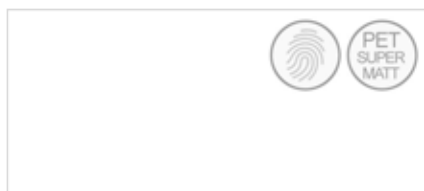

**BÍLÁ**  
77.M28.018.51



**BÍLÁ TEPLÁ**  
77.M28.018.52



**SLONOVÁ KOST**  
77.M28.018.49



**CAPPUCCINO**  
77.M28.018.4A



**ŠEDÁ**  
77.M28.018.09



**ČERNÁ**  
77.M28.018.54

## NÁBYTKOVÉ ABS HRANY LESK A SUPER MAT

(vzorkovník dekorů zdarma žádejte na zákaznickém servisu)



### > ABS HRANY VYSOKÝ LESK

ABS hrany o tloušťce 1,0 mm a výšce 23 mm, ve vysokém lesku, dodáváme v návinech jako součást dodávky MDF desek. Podmínka odběru není nákup desek a obráceně, tedy hrany i desky lze zakoupit samostatně. Ostatní rozměry a dekory hran (výška, tloušťka materiálu) je na dotaz. Hrany jsou identického dekoru jako MDF desky z naší nabídky, vyrobeno v Itálii.

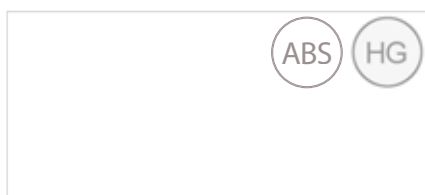

**BÍLÁ**  
78.G28.023.51

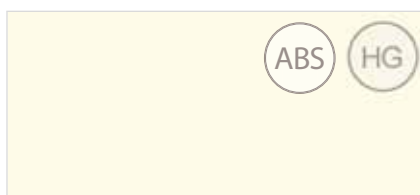

**SLONOVÁ KOST**  
78.G28.023.49

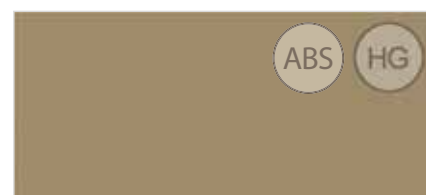

**CAPPUCCINO**  
78.G28.023.4A



**MOKKA**  
78.G28.023.87

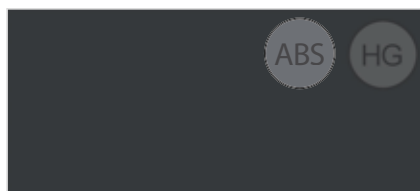

**ŠEDÁ**  
78.G28.023.27



**ČERNÁ**  
78.G28.023.54



### > ABS HRANY SUPER MAT

ABS hrany o tloušťce 1,0 mm a výšce 23 mm, v super matu, dodáváme v návinech jako součást dodávky MDF desek. Podmínka odběru není nákup desek a obráceně, tedy hrany i desky lze zakoupit samostatně. Ostatní rozměry a dekory hran (výška, tloušťka materiálu) je na dotaz. Hrany jsou identického dekoru jako MDF desky z naší nabídky, vyrobeno v Itálii.



**BÍLÁ**  
78.M28.023.51



**BÍLÁ TEPLÁ**  
78.M28.023.52



**SLONOVÁ KOST**  
78.M28.023.49



**CAPPUCCINO**  
78.M28.023.4A



**ŠEDÁ**  
78.M28.023.09



**ČERNÁ**  
78.M28.023.54

## > MDF DESKY BETON

MDF desky s povrchovou úpravou z pravého betonu. Každá deska je originál. Desky je možné použít k výrobě drobného nábytku, ale i k výrobě skříní nebo obkladů v interiéru. Betonová vrstva je standardně ponechána v surovém stavu, v případě potřeby jsou desky přímo výrobcem dodávány s transparentní povrchovou úpravou zabraňující ušpinění nebo jiné znehodnocení povrchu (použití na konferenční stoly, šatní skříně a podobně). Tento povrch je také možné čistit běžnými čistícími prostředky. Desky jsou voděodolné.

Minimální odběr je 15 ks desek v jakémkoli formátu, přičemž formáty jsou standardních rozměrů, ale dle požadavku zákazníka je možné je upravit.

Formáty standard v mm: 600x600, 900x900, 600x1200, 900x1200, 900x1800, 3500x900. Součástí dodávky je betonová pasta, která se jednoduše aplikuje na hranu desky, případně je možné ji požit v případě malých nedostaků způsobených zpracováním materiálu.

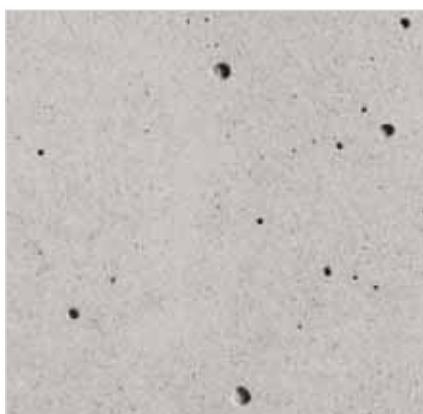

LISCIO  
77.B20.LIS.....ROZMĚR.....



ANDO  
77.B20.AND.....ROZMĚR.....



TAVOLATO  
77.B20.TAV.....ROZMĚR.....



## **OBJEDNÁVKY**

Podáním objednávky kupující stvrzuje, že se seznámil s těmito obchodními podmínkami včetně reklamačního řádu a že s nimi souhlasí. Objednávka je návrhem kupní smlouvy. Kupní smlouva vzniká v okamžiku převzetí objednaného zboží a daňového dokladu kupujícím. Objednávka musí obsahovat identifikaci kupujícího včetně fakturačních údajů, kontaktní osoby, telefonu, emailové adresy (nutná k registraci) a adresu dodání (pokud se liší od fakturační). V případě první objednávky je nutné zaslat mailem výpis z obchodního rejstříku a registraci o přidělení DIČ.

## **TERMÍN A ZPŮSOB DODÁNÍ**

Zboží je standardně expedováno tentýž nebo následující pracovní den od obdržení objednávky. Zboží je zasíláno formou balíků a paletových zásilek, každý pracovní den s doručením zpravidla do 24 hodin v rámci celé ČR. Osobní odběr může být proveden přímo v našem skladě v době od 7:30 do 15:30 hod.

## **CENOVÉ A PLATEBNÍ PODMÍNKY**

Základní ceny zboží se řídí aktuálně platným ceníkem. Individuální slevy je možné dohodnout na základě telefonického či osobního jednání. U prvních dodávek zboží vyžadujeme platbu v hotovosti nebo na dobírku. Platbu převodem nabízíme zákazníkům s dobrou platební morálkou, a to na základě podpisu rámcové smlouvy. Standardní termín splatnosti faktur je 14 dní, pokud není stanoveno jinak. V případě nadměrných nebo individuálně smluvených objednávek můžeme vyžadovat zálohovou platbu.

## **REKLAMACE**

Reklamované vady zboží týkající se množství a zjevné vady musí odběratel uplatnit u dodavatele okamžitě, nejpozději do 3 pracovních dnů od dodání. Skryté vady je odběratel povinen uplatnit ve lhůtě stanovené zákonem. Práva je nutno uplatnit písemnou formou. Při převzetí zboží od dopravce je odběratel povinen zkontrolovat úplnost obsahu zásilky a případné nesrovnalosti či poškození zapsat do přepravního listu. Pokud tak neučiní, má se za to, že odběratel převzal zásilku úplnou. Upozorňujeme, že přípustná množstevní odchylka v balení je + - 3% dle zákona.

## **INFORMACE O ZPRACOVÁNÍ OSOBNÍCH ÚDAJŮ (GDPR)**

INCOLL FERRAMENTA, s.r.o. v rámci své činnosti zpracovává osobní údaje, přitom pro jejich zpracování určuje účely a prostředky zpracování. INCOLL FERRAMENTA, s.r.o. je tedy v postavení správce osobních údajů. Ty zpracovává zejména u svých zákazníků, dodavatelů a poskytovatelů služeb, kterými jsou fyzické osoby a právnické osoby. To vše činí pouze v rámci své podnikatelské činnosti.

Veškeré informace týkající se GDPR jsou k dispozici na internetových stránkách [www.incoll.cz](http://www.incoll.cz)

+420 548 212 858  
+420 605 271 559



incoll@incoll.cz



**INCOLL FERRAMENTA, s.r.o.**

Malé Díly 401, 664 61 Rebešovice  
IČ: 29253934 | DIČ: CZ29253934



### KANCELÁŘ

pondělí: 8:00-16:00  
úterý: 8:00-16:00  
středa: 8:00-17:00  
čtvrtek: 8:00-16:00  
pátek: 7:30-14:30

### SKLAD

pondělí: 7:30-15:30  
úterý: 7:30-15:30  
středa: 7:30-16:30  
čtvrtek: 7:30-15:30  
pátek: 7:30-14:30



www.incoll.cz



KATALOG 2019



[www.incoll.cz](http://www.incoll.cz)